

**Telecommunications security;
Lawful Interception (LI);
Handover interface for the lawful interception of
telecommunications traffic**



Reference

DES/SEC-003003 (fh000icp.PDF)

Keywords

data, handover, interface, security, speech

ETSI

Postal address

F-06921 Sophia Antipolis Cedex - FRANCE

Office address

650 Route des Lucioles - Sophia Antipolis
Valbonne - FRANCE
Tel.: +33 4 92 94 42 00 Fax: +33 4 93 65 47 16
Siret N° 348 623 562 00017 - NAF 742 C
Association à but non lucratif enregistrée à la
Sous-Préfecture de Grasse (06) N° 7803/88

Internet

secretariat@etsi.fr
Individual copies of this ETSI deliverable
can be downloaded from
<http://www.etsi.org>
If you find errors in the present document, send your
comment to: editor@etsi.fr

Copyright Notification

No part may be reproduced except as authorized by written permission.
The copyright and the foregoing restriction extend to reproduction in all media.

© European Telecommunications Standards Institute 1999.
All rights reserved.

Contents

Intellectual Property Rights.....	8
Foreword.....	8
1 Scope.....	9
2 References.....	9
3 Definitions and abbreviations.....	11
3.1 Definitions.....	11
3.2 Abbreviations.....	14
4 General requirements.....	16
4.1 Basic principles for the handover interface.....	16
4.2 Legal requirements.....	16
4.3 Interfaces and process.....	16
4.4 Example process.....	17
5 Overview of handover interface.....	18
5.1 Handover interface port 1 (HI1).....	19
5.1.1 Manual interface.....	19
5.1.2 Electronic interface.....	19
5.2 Handover interface port 2 (HI2).....	19
5.3 Handover interface port 3 (HI3).....	20
5.3.1 Circuit switched, 64 kbit/s based services.....	20
5.3.2 User information messages.....	20
5.3.3 Packet switched data services.....	20
6 Specific identifiers for LI.....	20
6.1 Lawful interception identifier (LIID).....	20
6.2 Call identifier (CID).....	21
6.2.1 Network identifier (NID).....	21
6.2.2 Call identity number (CIN).....	21
6.3 CC link identifier (CCLID).....	21
6.4 Correlation between CC and IRI.....	22
6.5 Usage of Identifiers.....	22
7 HI1: Interface port for administrative information.....	23
7.1 Information for the activation of lawful interception.....	23
7.2 LI notifications towards the LEMF.....	24
8 HI2: Interface port for intercept related information.....	24
8.1 Data transmission link, protocol.....	25
8.1.1 Application for IRI (HI2 information).....	25
8.1.2 Application for LI notifications (HI1) and CC (HI3).....	26
8.2 Definition of intercept related information.....	26
8.3 Types of IRI records.....	26
8.4 Structure of IRI records.....	27
8.4.1 Control information for HI2.....	27
8.4.2 Basic call information.....	27
8.4.3 Information on supplementary services, related to a call in progress.....	28
8.4.4 Information on non call related supplementary services.....	29
8.5 Selection of parameters for IRI records.....	29
8.6 Coding of parameters in IRI records.....	31
8.7 Information content of the IRI record types.....	31
9 HI3: Interface port for content of communication.....	31
9.1 Delivery of circuit switched content of communication.....	32
9.2 Delivery of packetized content of communication (general).....	33
9.3 Control information for HI3.....	34

9.3.1	Circuit switched content of communication.....	34
9.3.2	Packetized content of communication	35
10	LI procedures for circuit switched supplementary services.....	35
10.1	General.....	35
10.2	CC link Impact.....	36
10.3	IRI Impact, General Principle for Sending IRI records.....	36
10.4	Multi party calls - general principles, options A, B.....	37
10.4.1	CC links for active and non-active calls (option A).....	37
10.4.2	Reuse of CC links for active calls (option B)	38
10.5	Subscriber Controlled Input (SCI): Activation / Deactivation / Interrogation of Services.....	39
11	Performance & quality	41
11.1	Timing.....	41
11.2	Quality.....	41
12	Exception handling	41
12.1	Failure of CC links.....	41
12.2	Failure of ROSE protocol stack	41
12.3	Fault reporting.....	42
12.4	Handling of Unrecognized Fields and Parameters	42
13	Security aspects.....	42
13.1	Security requirements at the interface port HI1.....	42
13.2	Security requirements at the interface port HI2.....	42
13.3	Security requirements at the interface port HI3.....	43
13.3.1	LI access verification.....	43
13.3.2	Access protection.....	43
13.3.3	Authentication	43
14	Quantitative aspects	43
Annex A (normative): Operation for sending of data across the HI interface		44
A.1	Syntax definitions	44
A.2	Object tree.....	45
A.3	HI management operation	45
A.4	LI management notification.....	46
A.5	Intercept related information (HI2).....	47
A.6	User data packet transfer (HI3 interface).....	53
A.7	TETRA data transfer (HI3 interface).....	54
A.8	GPRS data transfer (HI3 interface).....	54
A.9	Definition of the UUS1 content associated to the CC link.....	55
Annex B (normative): Detailed procedures for supplementary services (circuit switched).....		56
B.1	Advice of Charge Services (AOC).....	56
B.2	Call Waiting	56
B.2.1	Call Waiting at target: CC links	56
B.2.2	Call Waiting: IRI records.....	56
B.2.2.1	Target is served user.....	56
B.2.2.2	Other party is served user	56
B.3	Call Hold/Retrieve	56
B.3.1	CC links for active and non-active calls (option A)	56
B.3.2	Reuse of CC links for active calls (option B).....	57
B.3.3	IRI records	57
B.3.3.1	Invocation of Call Hold or Retrieve by target:	57

B.3.3.2	Invocation of Hold or Retrieve by other parties:	57
B.4	Explicit Call Transfer.....	57
B.4.1	Explicit Call Transfer, CC link.....	57
B.4.2	Explicit Call Transfer, IRI records.....	57
B.5	Calling Line Identification Presentation (IRI Records).....	58
B.5.1	Call originated by target (target is served user).....	58
B.5.2	Call terminated at target (other party is served user).....	58
B.6	Calling Line Identification Restriction (CLIR).....	58
B.7	Connected Line Identification Presentation (COLP).....	58
B.7.1	Call terminated at target (target is served user).....	58
B.7.2	Call originated by target (other party is served user)	58
B.8	Connected Line Identification restriction (COLR).....	58
B.9	Closed User Group (CUG).....	58
B.10	Completion of Call to Busy Subscriber (CCBS)	59
B.11	Conference Call, Add-On (CONF)	59
B.11.1	Conference Calls, Add On: CC links.....	59
B.11.2	Conference Calls: IRI records	59
B.12	Three Party Service (Conference).....	59
B.12.1	CC links.....	59
B.12.2	Three Party Service, IRI Records.....	59
B.13	Meet-Me Conference (MMC).....	60
B.14	Direct Dialing In (DDI).....	60
B.15	Multiple Subscriber Number (MSN)	60
B.16	Diversion Services (DIV).....	60
B.16.1	Call Diversion by Target.....	60
B.16.1.1	Call Diversion by Target, CC links.....	60
B.16.1.2	Call Diversion by Target, IRI records	61
B.16.2	Forwarded Call Terminated at Target	61
B.16.3	Call from Target Forwarded.....	61
B.17	Variants of call diversion services	61
B.18	Freephone (FPH).....	61
B.19	Malicious Call Identification (MCID)	61
B.20	Subaddressing (SUB).....	61
B.21	Terminal Portability (TP).....	61
B.21.1	CC links.....	61
B.21.2	IRI records	62
B.21.2.1	Invocation of Terminal Portability by target.....	62
B.21.2.2	Invocation of Terminal Portability by other parties.....	62

B.22	User-to-User Signalling (UUS).....	62
B.23	Abbreviated Address (AA)	62
B.24	Fixed Destination Call (FDC).....	62
B.25	Alarm Call (AC) / Wake Up Service (WUS).....	62
B.26	Incoming Call Barring (ICB)	62
B.27	Outgoing Call Barring (OCB).....	63
B.28	Completion of Calls on No Reply (CCNR)	63
B.29	Reverse Charging	63
B.30	Line Hunting	63
B.31	Message Wait Indication (MWI)	63
B.32	Name display.....	63
B.33	Tones, Announcements.....	63
Annex C (normative): Application Service Element for the Handover Interface (ASE_HI)		64
C.1	Architecture.....	64
C.2	ASE_HI procedures	64
C.2.1	Sending part	64
C.2.2	Receiving part	66
C.2.3	Data link management.....	66
C.2.3.1	Data link establishment.....	66
C.2.3.2	Data link release	67
Annex D (informative): Overview description for CC link and IRI delivery - state model.....		68
Annex E (informative): Message Sequence Diagrams, IRI content		71
E.1	General remarks	71
E.2	Remarks to tables	72
E.3	Remarks to scenarios	72
E.4	Originating target, basic call	73
E.4.1	Initial LI procedures.....	73
E.4.2	Set up of an additional call leg	75
E.4.3	IRI-CONTINUE records (general).....	75
E.4.4	Answer by other party	75
E.4.5	Call release (originating or terminating target)	76
E.5	Terminating target, basic call.....	78
E.5.1	Initial LI procedure	78
E.5.2	Answer by target	79
E.5.3	Call release.....	80
E.6	Originating target call, invocation of LI relevant services	80
E.6.1	Call forwarded by called party	80
E.7	Terminating target call, invocation of LI relevant services	82
E.7.1	Terminating call at target is a forwarded call	82
E.7.2	Call forwarded by target.....	82
E.7.3	Target invokes Call Waiting (CW)	85
E.8	Target actions during a call in progress	85
E.8.1	Call HOLD by target.....	86
E.8.2	Call RETRIEVE by target.....	86

E.9	Three Party Service (3PTY).....	87
E.9.1	Target establishes Three Party Conference (3PTY).....	87
E.9.2	Target: Private communication with Active-Idle party	88
E.9.3	Target: Private communication with Active-Held party.....	88
E.9.4	Release of 3 PTY conference by Active-Held party	89
E.9.5	Release of 3 PTY conference by Active-Idle party	89
E.10	Add on conference (CONF).....	89
E.10.1	Mapping of PartyId / ConferenceId to call identifiers.....	89
E.10.2	Beginning a conference from the Idle call state	90
E.10.3	Beginning a conference from the Active call state	91
E.10.4	Adding a remote user	91
E.10.5	Splitting a remote user.....	92
E.10.6	Further actions during a conference	93
E.10.7	Target clears the conference.....	94
E.10.8	Option B (CC link only for active call)	95
E.10.9	Add on conference using other protocols.....	95
E.11	Target exchange receives notification related to other party	95
E.12	Service Activation (not call related)	96
E.13	Service activation / invocation during a call.....	96
E.13.1	ISDN accesses.....	96
E.13.2	Analogue accesses.....	97
E.14	Unsuccessful calls from target (originating), IRI-BEGIN record sent	97
E.15	Unsuccessful calls from / to target, IRI-BEGIN record not sent	98
Annex F (informative): Use of subaddress to carry correlation information		99
F.1	Introduction.....	99
F.2	Subaddress options.....	99
F.3	Subaddress coding.....	99
F.3.1	BCD Values	99
F.3.2	Field order and layout	100
F.4	Field coding.....	101
F.4.1	Direction	101
F.4.2	Basic Service.....	101
F.5	Length of fields	101
Bibliography.....		102
History		103

Intellectual Property Rights

IPRs essential or potentially essential to the present document may have been declared to ETSI. The information pertaining to these essential IPRs, if any, is publicly available for **ETSI members and non-members**, and can be found in SR 000 314: *"Intellectual Property Rights (IPRs); Essential, or potentially Essential, IPRs notified to ETSI in respect of ETSI standards"*, which is available **free of charge** from the ETSI Secretariat. Latest updates are available on the ETSI Web server (<http://www.etsi.org/ipr>).

Pursuant to the ETSI IPR Policy, no investigation, including IPR searches, has been carried out by ETSI. No guarantee can be given as to the existence of other IPRs not referenced in SR 000 314 (or the updates on the ETSI Web server) which are, or may be, or may become, essential to the present document.

Foreword

This ETSI Standard (ES) has been produced by ETSI Technical Committee Security (SEC).

1 Scope

The present document is step 3 of a three step approach to describe a generic handover interface for the provision of lawful interception from a Network Operator, an Access Provider or a Service Provider (NWO/AP/SvP) to the Law Enforcement Agencies (LEAs). The provision of lawful interception is a requirement of national law, which is usually mandatory for the operation of any telecommunication service. The aim of the present document is also to fulfil the user requirements for a future mutual assistance between the LEAs of different countries.

Interworking with other countries than those following the present document is for further study.

Step 1 contains the requirements for lawful interception from a users (LEAs) point of view and is published as ETR 331 [1].

The derived network functions and the general architecture (or functional model) is described in the step 2 document, ES 201 158 [2].

The present document specifies the *generic flow of information* as well as the procedures and information elements, which are applicable to any future telecommunication network or service.

The standard specifies in detail network/service specific protocols relating to the provision of lawful interception at the handover interface, for the following networks/services:

- speech;
- circuit and packet switched data;
- UMTS and similar services.

NOTE: As there are several types of new networks and/or services currently being developed, the present document will subsequently be expanded as soon as the relevant standards will be available as stable drafts. The revisions of the present document, containing these amendments in additional sections, will be published.

Version 1.1.1 will be limited to 64 kbit/s for circuit switched content of communication and certain packetized services.

Where applicable, the present document bases on other ETSI standards or ITU-T Recommendations in the area of telecommunication services. The reader should be familiar with the referenced standards/recommendations, including the ITU Recommendations, which are endorsed by many of the referenced ETSI standards.

2 References

The following documents contain provisions which, through reference in this text, constitute provisions of the present document.

- References are either specific (identified by date of publication, edition number, version number, etc.) or non-specific.
- For a specific reference, subsequent revisions do not apply.
- For a non-specific reference, the latest version applies.
- A non-specific reference to an ETS shall also be taken to refer to later versions published as an EN with the same number.

[1] ETR 331: "Security Techniques Advisory Group (STAG); Definition of user requirements for lawful interception of telecommunications; Requirements of the law enforcement agencies".

[2] ES 201 158: "Telecommunications security; Lawful Interception (LI); Requirements for network functions".

- [3] ETR 330: "Security Techniques Advisory Group (STAG); A guide to legislative and regulatory environment".
- [4] ITU-T Recommendation X.25: "Interface between Data Terminal Equipment (DTE) and Data Circuit-terminating Equipment (DCE) for terminals operating in the packet mode and connected to public data networks by dedicated circuit".
- [5] EN 300 356-1 to 20: "Integrated Services Digital Network (ISDN); Signalling System No.7; ISDN User Part (ISUP) version 3 for the international interface; Parts 1 to 20".
- [6] EN 300 403-1 (V1.2): "Integrated Services Digital Network (ISDN); Digital Subscriber Signalling System No. one (DSS1) protocol; Signalling network layer for circuit-mode basic call control; Part 1: Protocol specification [ITU-T Recommendation Q.931 (1993), modified]".
- [7] Void.
- [8] Void.
- [9] Void.
- [10] EN 300 061-1: "Integrated Services Digital Network (ISDN); Subaddressing (SUB) supplementary service; Digital Subscriber Signalling System No. one (DSS1) protocol; Part 1: Protocol specification".
- [11] Void.
- [12] Void.
- [13] Void.
- [14] EN 300 097-1 including Amendment 1: "Integrated Services Digital Network (ISDN); Connected Line Identification Presentation (COLP) supplementary service; Digital Subscriber Signalling System No. one (DSS1) protocol; Part 1: Protocol specification".
- [15] EN 300 098-1: "Integrated Services Digital Network (ISDN); Connected Line Identification Restriction (COLR) supplementary service; Digital Subscriber Signalling System No. one (DSS1) protocol; Part 1: Protocol specification".
- [16] EN 300 130-1: "Integrated Services Digital Network (ISDN); Malicious Call Identification (MCID) supplementary service; Digital Subscriber Signalling System No. one (DSS1) protocol; Part 1: Protocol specification".
- [17] EN 300 138-1 including Amendment 1: "Integrated Services Digital Network (ISDN); Closed User Group (CUG) supplementary service; Digital Subscriber Signalling System No. one (DSS1) protocol; Part 1: Protocol specification".
- [18] Void.
- [19] EN 300 185-1: "Integrated Services Digital Network (ISDN); Conference call, add-on (CONF) supplementary service; Digital Subscriber Signalling System No. one (DSS1) protocol; Part 1: Protocol specification".
- [20] ETS 300 188-1: "Integrated Services Digital Network (ISDN); Three-Party (3PTY) supplementary service; Digital Subscriber Signalling System No. one (DSS1) protocol; Part 1: Protocol specification".
- [21] EN 300 207-1 (V1.2): "Integrated Services Digital Network (ISDN); Diversion supplementary services; Digital Subscriber Signalling System No. one (DSS1) protocol; Part 1: Protocol specification".
- [22] Void.
- [23] EN 300 286-1: "Integrated Services Digital Network (ISDN); User-to-User Signalling (UUS) supplementary service; Digital Subscriber Signalling System No. one (DSS1) protocol; Part 1: Protocol specification".

- [24] Void.
- [25] EN 300 369-1 (V1.2): "Integrated Services Digital Network (ISDN); Explicit Call Transfer (ECT) supplementary service; Digital Subscriber Signalling System No. one (DSS1) protocol; Part 1: Protocol specification".
- [26] Void.
- [27] Void.
- [28] Void.
- [29] EN 300 196-1 (V1.2): "Integrated Services Digital Network (ISDN); Generic functional protocol for the support of supplementary services; Digital Subscriber Signalling System No. one (DSS1) protocol; Part 1: Protocol specification".
- [30] Void.
- [31] ITU-T Recommendation Q.850: "Usage of cause and location in the Digital Subscriber Signalling System No. 1 and the Signalling System No. 7 ISDN User Part".
- [32] GSM 09.02: "Digital cellular telecommunications system (Phase 2+); Mobile Application Part (MAP) specification".
- [33] ITU-T Recommendation X.208: "Specification of Abstract Syntax Notation One (ASN.1)".
- [34] ITU-T Recommendation X.209: "Specification of basic encoding rules for Abstract Syntax Notation One (ASN.1)".
- [35] ITU-T Recommendation X.880: "Information technology - Remote Operations: Concepts, model and notation".
- [36] ITU-T Recommendation X.881: "Information technology - Remote Operations: OSI realizations - Remote Operations Service Element (ROSE) service definition".
- [37] ITU-T Recommendation X.882: "Information technology - Remote Operations: OSI realizations - Remote Operations Service Element (ROSE) protocol specification".
- [38] Void.
- [39] EN 300 122-1: "Integrated Services Digital Network (ISDN); Generic keypad protocol for the support of supplementary services; Digital Subscriber Signalling System No. one (DSS1) protocol; Part 1: Protocol specification".
- [40] ETS 300 392-1: "Terrestrial Trunked Radio (TETRA); Voice plus Data (V+D); Part 1: General network design".

3 Definitions and abbreviations

3.1 Definitions

For the purposes of the present document, the terms and definitions given in [1] and [2] apply.

They are reproduced in the list below as required, and defined further as necessary:

access provider: access provider provides a user of some network with access from the user's terminal to that network.

NOTE 1: This definition applies specifically for the present document. In a particular case, the access provider and network operator may be a common commercial entity.

NOTE 2: The definitions from ETR 331 have been expanded to include reference to an access provider, where appropriate.

activation/deactivation: procedures for activation, which is the operation of bringing the service into the "ready for invocation" state, and deactivation, which is the complementary action, are described in this clause. For some services there may be a specific user procedure to allow activation and deactivation as necessary, whilst for others the service is permanently activated on provision and thus no procedure is provided (see [37]).

(to) buffer: temporary storing of information in case the necessary telecommunication connection to transport information to the LEMF is temporarily unavailable.

call: any temporarily switched connection capable of transferring information between two or more users of a telecommunications system. In this context a user may be a person or a machine.

call identifier: see definition in clause 6.

call identity number: see definition in clause 6.

CC link: CC link consists of one or more 64 kbit/s channels, established simultaneously, between a mediation function and a LEMF; it is used for transmission of the content of communication.

CC link identifier: see definition in clause 6.

content of communication: information exchanged between two or more users of a telecommunications service, excluding intercept related information. This includes information which may, as part of some telecommunications service, be stored by one user for subsequent retrieval by another.

handover interface: physical and logical interface across which the interception measures are requested from network operator / access provider / service provider, and the results of interception are delivered from a network operator / access provider / service provider to a law enforcement monitoring facility.

identity: technical label which may represent the origin or destination of any telecommunications traffic, as a rule clearly identified by a physical telecommunications identity number (such as a telephone number) or the logical or virtual telecommunications identity number (such as a personal number) which the subscriber can assign to a physical access on a case-by-case basis.

interception: action (based on the law), performed by an network operator / access provider / service provider, of making available certain information and providing that information to a law enforcement monitoring facility.

NOTE 3: In the present document the term interception is not used to describe the action of observing communications by a law enforcement agency.

interception configuration information: information related to the configuration of interception.

Interception interface: physical and logical locations within the network operator's / access provider's / service provider's telecommunications facilities where access to the content of communication and intercept related information is provided. The interception interface is not necessarily a single, fixed point.

interception measure: technical measure which facilitates the interception of telecommunications traffic pursuant to the relevant national laws and regulations.

intercept related information: collection of information or data associated with telecommunication services involving the target identity, specifically call associated information or data (e.g. unsuccessful call attempts), service associated information or data (e.g. service profile management by subscriber) and location information.

interception subject: person or persons, specified in a lawful authorization, whose telecommunications are to be intercepted.

internal intercepting function: point within a network or network element at which the content of communication and the intercept related information are made available.

internal network interface: network's internal interface between the Internal Intercepting Function and a mediation device.

invocation and operation: describes the action and conditions under which the service is brought into operation; in the case of a lawful interception this may only be on a particular call. It should be noted that when lawful interception is activated, it shall be invoked on all calls (Invocation takes place either subsequent to or simultaneously with activation.). Operation is the procedure which occurs once a service has been invoked.

NOTE 4: The definition is based on [37], but has been adapted for the special application of lawful interception, instead of supplementary services.

law enforcement agency: organization authorized by a lawful authorization based on a national law to request interception measures and to receive the results of telecommunications interceptions.

law enforcement monitoring facility: law enforcement facility designated as the transmission destination for the results of interception relating to a particular interception subject.

lawful authorization: permission granted to a LEA under certain conditions to intercept specified telecommunications and requiring co-operation from a network operator / access provider / service provider. Typically this refers to a warrant or order issued by a lawfully authorized body.

lawful interception: see interception.

lawful interception identifier: see definition in clause 6.

location information: information relating to the geographic, physical or logical location of an identity relating to an interception subject.

mediation device: equipment, which realizes the mediation function.

mediation function: mechanism which passes information between a network operator, an access provider or service provider and a handover interface, and information between the internal network interface and the handover interface.

network element: component of the network structure, such as a local exchange, higher order switch or service control processor.

network element identifier: see definition in clause 6.

network identifier: see definition in clause 6.

network operator: operator of a public telecommunications infrastructure which permits the conveyance of signals between defined network termination points by wire, by microwave, by optical means or by other electromagnetic means.

quality of service: quality specification of a telecommunications channel, system, virtual channel, computer-telecommunications session, etc. Quality of service may be measured, for example, in terms of signal-to-noise ratio, bit error rate, message throughput rate or call blocking probability.

reliability: probability that a system or service will perform in a satisfactory manner for a given period of time when used under specific operating conditions.

result of interception: information relating to a target service, including the content of communication and intercept related information, which is passed by a network operator, an access provider or a service provider to a law enforcement agency. Intercept related information shall be provided whether or not call activity is taking place.

service information: information used by the telecommunications infrastructure in the establishment and operation of a network related service or services. The information may be established by a network operator, an access provider, a service provider or a network user.

service provider: natural or legal person providing one or more public telecommunications services whose provision consists wholly or partly in the transmission and routing of signals on a telecommunications network. A service provider needs not necessarily run his own network.

target identity: technical identity (e.g. the interception's subject directory number), which uniquely identifies a target of interception. One target may have one or several target identities.

target service: telecommunications service associated with an interception subject and usually specified in a lawful authorization for interception.

NOTE 5: There may be more than one target service associated with a single interception subject.

telecommunications: any transfer of signs, signals, writing images, sounds, data or intelligence of any nature transmitted in whole or in part by a wire, radio, electromagnetic, photoelectronic or photo-optical system.

3.2 Abbreviations

For the purposes of the present document, the following abbreviations apply:

3PTY	Three-Party Service
AA	Abbreviated Address
AC	Alarm Call
ACM	Address Complete Message
AOC	Advice of Charge Service
AP	Access Provider
ASN.1	Abstract Syntax Notation, Version 1
ASE	Application Service Element
ATM	Asynchronous Transfer Mode
BA	DSS1 Basic Access
BC	Bearer Capability
BER	Basic Encoding Rules
BS	Basic Service
CC	Content of Communication
CCBS	Completion of Calls to Busy Subscriber
CCNR	Completion of Calls on No Reply
CD	Call Deflection
CF	Call Forwarding
CFB	Call Forwarding on Busy
CFNR	Call Forwarding on No Reply
CFU	Call Forwarding Unconditional
CH	Call Hold
CCLID	CC Link Identifier
CID	Call Identifier
CIN	Call Identity Number
CLI	Calling Line Identity (Calling Party Number)
CLIP	Calling Line Identification Presentation
CLIR	Calling Line Identification Restriction
COL	Connected Line Identity (Connected Number)
COLP	Connected Line Identification Presentation
COLR	Connected Line Identification Restriction
CONF	Conference Call, Add-on
CPG	Call Progress Message
CUG	Closed User Group
CW	Call Waiting
DDI	Direct Dialing In
DIV	Call Diversion Services
DN	Directory Number
DSS1	Digital Subscriber Signalling system No.1
DTMF	Dual Tone Multi-Frequency
ECT	Explicit Call Transfer
FB	Fallback Procedure
FDC	Fixed Destination Call
FPH	Freephone
GPRS	Global Packet radio Service
GSM	Global System for Mobile communications
HI	Handover Interface
HI1	Handover Interface Port 1 (for Administrative Information)
HI2	Handover Interface Port 2 (for Intercept Related Information)
HI3	Handover Interface Port 3 (for Content of Communication)
HLC	High Layer Compatibility
HOLD	Call Hold Service
IA5	International Alphabet No. 5
IAM	Initial Address Message
IAP	Interception Access Point
ICB	Incoming Call Barring

ICC	Interception Control Centre
ICI	Interception Configuration Information
IE	Information Element
IIF	Internal Intercepting Function
IMEI	International Mobile station Equipment Identity
IMSI	International Mobile Subscriber Identity
IN	Intelligent Network
INI	Internal network interface
IP	Internet Protocol
IRI	Intercept Related Information
ISDN	Integrated services digital network
ISUP	ISDN user part
LEA	Law Enforcement Agency
LEMF	Law Enforcement Monitoring Facility
LI	Lawful Interception
LIID	Lawful Interception Identifier
LLC	Lower layer compatibility
LSB	Least significant bit
MAP	Mobile Application Part
MCID	Malicious Call Identification
MF	Mediation Function
MMC	Meet-me Conference
MSB	Most significant bit
MSN	Multiple Subscriber Number
NDUB	Network Determined User Busy
NEID	Network Element Identifier
NID	Network Identifier
NWO	Network Operator
OA&M	Operation, Administration & Maintenance
OCB	Outgoing Call Barring
PLMN	Public land mobile network
PR	Partial Rerouting
PRA	ISDN Primary Rate Access
PSPDN	Packet switched public data network
PSTN	Public Switched Telephone Network
ROSE	Remote Operation Service Element
R _x	Receive direction
SCI	Subscriber Controlled Input
SCF	IN Signalling Control Function
SMS	Short Message Service
SS	Supplementary Service
SS No.7	Common Channel Signalling System ITU(T) No. 7
SSF	IN Signalling Switching Function
STC	Sub-Technical Committee
SUB	Subaddressing Supplementary Service
SvP	Service Provider
TCP	Transmission Control Protocol
TE	Target Exchange
TETRA	Trans European Trunked Radio
TI	Target identity
TMR	Transmission Medium Requirement
TP	Terminal Portability
T _x	Transmit direction
UDUB	User Determined User Busy
UMTS	Universal Mobile Telecommunication System
USI	User Service Information
UUS	User-to-User Signalling
UUS1,2,3	User-to-User Signalling service 1,2,3
WUS	Wake-Up Service

4 General requirements

The present document focuses on the handover interface related to the provision of information related to LI between a network operator, access provider and/or service provider and a Law Enforcement Agency (LEA).

4.1 Basic principles for the handover interface

The network requirements mentioned in The present document are derived, in part, from the requirements defined in ES 201 158 [2].

Lawful interception requires functions to be provided in all, or some of, the switching nodes of a telecommunications network. Implementation of LI handover functionality according to edition 1 of the present document, shall be applicable at least to the following types of networks:

- 1) PSTN including ISDN;
- 2) PLMN.

The specification of the handover interface is subdivided into three parts, considering the different purposes and types of information being exchanged.

Note that the interface is intended to be extensible and will be extended in future, e.g. due to the introduction of new services. Additional network services shall be covered in future editions of the present document. The LEMF shall handle change, such as new data elements, using a simple compatibility mechanism.

4.2 Legal requirements

It shall be possible to select elements from the handover interface specification to:

- conform to national requirements;
- conform with national law;
- conform with the law applicable to a specific LEA.

As a consequence, the present document shall define, in addition to mandatory requirements, which are always applicable, supplementary options, in order to take into account the above listed various influences. See also [1] and [3].

4.3 Interfaces and process

In the ES Lawful Interception - Requirements for Network Functions [2] a functional role model is described as a reference example to show the typical procedural operation of interception, and the typical responsibilities of the various players.

Some major aspects are summarized here.

If a LEA wishes to use lawful interception as a tool for intercepting the telecommunication of an individual, that LEA will apply via the responsible body for a lawful authorization, such as a warrant. If the lawful authorization is granted the LEA will present it to the NWO/AP/SvP via an administrative procedure. This procedure is performed via the handover interface port for administrative purposes, HI1 (see Figure 1).

When the functions for lawful interception are activated, the intercept related information and/or the content of communication is delivered to the LEMF of a LEA. For delivery of intercept related information, e.g. the directory number of the interception subject's communication partner, service information, time stamps etc., the handover interface port HI2 is defined. For delivery of the content of communication, e.g. speech or data, the handover interface port HI3 is defined.

The present document does not explicitly specify, in which network element the functions for LI should be performed. The location of the IIF, as shown in Figure 1, depends on the type of network (e.g. fixed network ISDN, GSM network, ...) and its structure. The available information, especially with respect to IRI, may depend on the location of the IIF.

A lawful authorization shall describe the kind of information (CC and/or IRI) that is required by this LEA, the interception subject, the start and stop time of LI, and the addresses of the LEAs for CC and/or IRI and further information.

A single interception subject may be the subject to interception by different LEAs. It shall be possible strictly to separate these interception measures.

If two targets are communicating with each other, each target has their own CC links and IRI records.

The law may require that checks and audits are possible. Therefore there shall be facilities at the access provider, network operator, service provider, and/or LEA that make such required checks and audits possible.

4.4 Example process

The process as described in this section stands as an example. In a specific country, the national process will be based on various national laws and circumstances.

The authorization authority requires, through the LEA, the interception of the interception subject when the latter uses a service via the telecommunication network. The LEA receives the communications involving the target identity(ies) which the network operator, access provider, or service provider (NWO/AP/SvP) singly or severally have associated with the interception subject.

The following scenario may take place:

- 1) A LEA requests lawful authorization from an authorization authority.
- 2) The authorization authority issues a lawful authorization to the LEA.
- 3) The LEA passes the lawful authorization to the NWO/AP/SvP (port HI1). The NWO/AP/SvP determines the relevant target identities from the information given in the lawful authorization.
- 4) The NWO/AP/SvP causes interception facilities to be applied to the relevant target identities.
- 5) The NWO/AP/SvP informs the LEA that the lawful authorization has been received and acted upon.
- 6) Intercept related information and content of communication are passed from the NWO/AP/SvP to the LEMF of the LEA (ports HI2, HI3).
- 7) Either on request from the LEA or when the period of authority of the lawful authorization has expired the NWO/AP/SvP will cease the interception arrangements.
- 8) The NWO/AP/SvP announces this cessation to the LEA (port HI1).

5 Overview of handover interface

The generic handover interface adopts a three port structure such that administrative information (HI1), intercept related information (HI2) and the content of communication (HI3) are logically separated.

Figure 1 shows a block diagram with the relevant entities for Lawful Interception.

The inner circle contains the switching functions of the network, where the results of interception (IRI, CC) are generated.

The internal interception functions (IIF) provide the content of communication (CC) and the intercept related information (IRI), respectively, at the internal network interface INI. For both kinds of information, mediation functions may be used, which provide the final representation of the standardized handover interfaces at the NWO/AP/SvP's domain boundary.

Within the NWO/AP/SvP's administration centre, the LI related tasks, as received via interface HI1, are translated into man machine commands for the NWO/AP/SvP's equipment.

Depending on the type of network, there might be a need to standardize also some or all of the internal network interfaces (INI). Such standards are not in the scope of the present document.

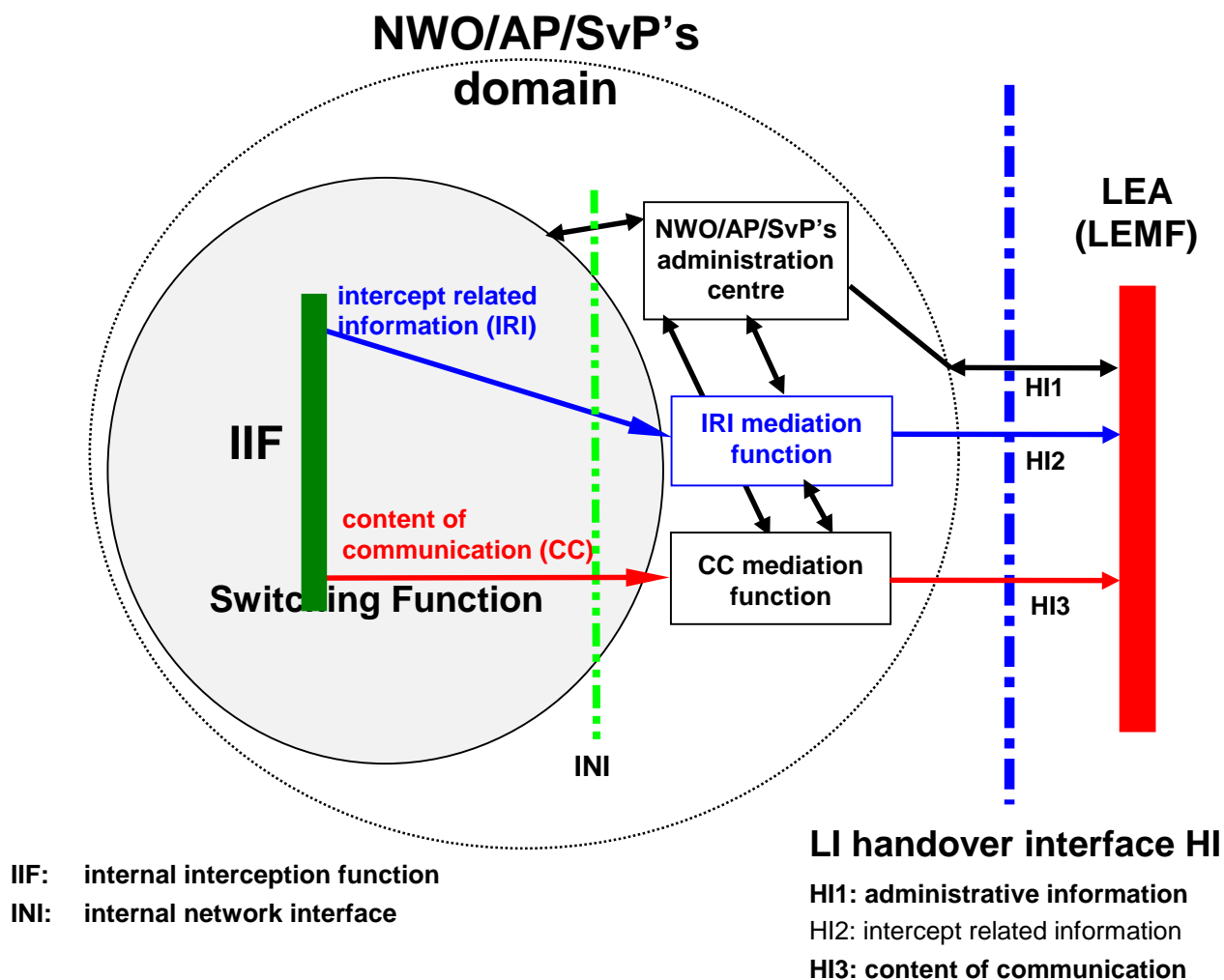

NOTE 1: Figure 1 shows only a reference configuration, with a logical representation of the entities involved in lawful interception and does not mandate separate physical entities.

NOTE 2: The mediation functions may be transparent.

Figure 1: Functional block diagram showing handover interface HI

5.1 Handover interface port 1 (HI1)

The handover interface port 1 shall transport various kinds of administrative information from/to the LEA and the organization at the NWO/AP/SvP, which is responsible for LI matters. This interface may be manual or electronic.

The HI1 interface may be crossing borders between countries. This possibility is subject to corresponding international laws or agreements.

A complete separation is required between the administrative part (HI1) and the technical part (INI) of the interface. No direct access to the switching function shall be given to the LEMF. Activation, deactivation or modification of an interception in the switching function shall only be possible by the NWO/AP/SvP.

However, as an option, in direction to the LEA, some HI1 related information may be delivered directly.

Further description of HI1 is given in clause 7.

5.1.1 Manual interface

If the HI1 is designed as a manual interface, it will normally consist of paper documents. The request for lawful interception may be sent via letter or via fax to the administration centre of the NWO/AP/SvP. The personnel of the administration centre will take the request and activate it in the network element (activation of interception). After the interception specified in the warrant is activated, the LEA will be informed, see clause 7. From this point in time on, the LEA shall be prepared to receive intercept related information (IRI) via HI2 and content of communication (CC) via HI3.

5.1.2 Electronic interface

An alternative solution may be the electronic transmission of the request for lawful interception. A practical system is for further study. An initial definition of an HI1 mechanism may be found in the ASN.1 syntax of Annex A.

The information content shall be such that the authorized agent of the NWO/AP/SvP is able to map it to the information which is required to activate the interception with a minimum of manual translation. This principle reduces the probability of errors.

5.2 Handover interface port 2 (HI2)

The handover interface port 2 shall transport the intercept related information (IRI) from the NWO/AP/SvP's IIF to the LEMF.

The delivery shall be performed via data communication methods which are suitable for the network infrastructure and for the kind and volume of data to be transmitted.

For the application layer, ROSE shall be used.

The delivery can in principle be made via different types of lower communication layers, which should be standard or widely used data communication protocols.

The individual IRI parameters shall be coded using ASN.1 and the basic encoding rules (BER). The format of the parameter's information content shall be based on existing telecommunication standards, where possible.

The IRI records contain information, which is available from the normal call handling procedures; additionally, they include information for identification and control purposes, which is needed by the HI2 port. The IIF is not required to make any attempt to request explicitly, via special call handling procedures, extra information, e.g. a calling party number, which has not already been supplied by a signalling system.

The HI2 data communication links and protocols provide a general means of data communication between the LEA and the NWO/AP/SvP's mediation function. It can in principle also be used for the transfer of other types of information, which logically belong to the interface ports HI1 and HI3. Specific ROSE components are used for these types of information.

5.3 Handover interface port 3 (HI3)

5.3.1 Circuit switched, 64 kbit/s based services

The handover interface port 3 shall transport the content of communication from the NWO/AP/SvP's mediation function to the LEMF. For 64 kbit/s based services, the content of communication shall be delivered to the LEMF via circuit-switched 64 kbit/s connections. Two options exist; they depend on the infrastructure, which is used for delivery:

- 1) Standard circuit switched ISDN connections, set up on demand towards the LEMF, for each target communication.
- 2) Use of a dedicated LI delivery network. The access to the delivery network shall use the same methods as defined above, i.e. standard ISDN procedures. From the handover interface point of view, this option is handled in the same way as method 1 above. No specific HI-relevant requirements are identified.

NOTE: The capacity of the HI3 connection to the LEMF should be adequate for the traffic which has to be intercepted.

5.3.2 User information messages

Delivery of user information messages, which are part of protocols for circuit switched connections, like UUS or SMS, may use dedicated ROSE components on the same lower layer data communication protocols as those used for the HI2 port.

5.3.3 Packet switched data services

For further study.

6 Specific identifiers for LI

6.1 Lawful interception identifier (LIID)

For each target identity related to an interception measure, the authorized NWO/AP/SvP operator shall assign a special lawful interception identifier (LIID), which has been agreed between the LEA and the NWO/AP/SvP. It is used within parameters of all HI interface ports.

Using an indirect identification, pointing to a target identity makes it easier to keep the knowledge about a specific interception target limited within the authorized NWO/AP/SvP operators and the handling agents at the LEA.

The lawful interception identifier LIID is a component of the CC (within set-up procedure of the CC link) and of the IRI records. It shall be used within any information exchanged at the handover interfaces HI2 and HI3 for identification and correlation purposes.

The LIID format shall consist of alphanumeric characters. It might for example, among other information, contain a warrant reference number, and the date, when the warrant was issued.

The authorized NWO/AP/SvP shall enter for each target identity of the interception subject a unique LIID.

EXAMPLE: The interception subject has an ISDN access with three MSNs. The NWO/AP/SvP enters for each MSN an own LIID.

If more than one LEA intercepts the same target identity, there shall be unique LIIDs assigned, relating to each LEA.

6.2 Call identifier (CID)

For each call or other activity relating to a target identity a CID is generated by the relevant network element. The CID consists of the following two identifiers:

- Network identifier (NID);
- Call Identity Number (CIN).

The CID distinguishes between the different calls of the target identity. It is also used for correlation between IRI records and CC connections. It is used at the interface ports HI2 and HI3.

The call identifier is specified in the subsections below. For ASN.1 coding details, see Annex A.

6.2.1 Network identifier (NID)

The network identifier is a mandatory parameter; it should be internationally unique. It consists of the following two identifiers:

- 1) NWO/AP/SvP- identifier (mandatory):
Unique identification of network operator, access provider or service provider.
- 2) Network element identifier NEID (optional):
The purpose of the network element identifier is to uniquely identify the relevant network element carrying out the LI operations, such as LI activation, IRI record sending,

A network element identifier may be:

- an E.164 international node number in the case of circuit switched networks, such as ISDN, PSTN, GSM;
- a X.25 address;
- an IP address.

6.2.2 Call identity number (CIN)

The call identity number is a temporary identifier of an intercepted call, relating to a specific target identity, to identify uniquely an intercepted call.

This parameter is mandatory for call related IRI.

6.3 CC link identifier (CCLID)

This identifier is only used at the interface ports HI2 and HI3 in case of the reuse of CC links (option B, see subclause 10.4.2).

For each CC link, which is set up by the mediation function towards the LEMF, a CC link identifier (CCLID) is transmitted in the HI2 records and HI3 setup message in addition to CIN and NID. For the correct correlation of multiparty calls this identity number indicates in the IRI records of each multiparty call, which CC link is used for the transmission of the CC.

The CCLID may use the same format as the CIN; in this case, it need not be transmitted explicitly during set up of the CC links, as part of HI3. The CIN may also implicitly represent the CCLID.

6.4 Correlation between CC and IRI

To assure correlation between the independently transmitted content of communication (CC) and intercept related information (IRI) of an intercepted call the following parameters are used:

- Lawful Interception Identifier (LIID), see subclause 6.1;
- Call Identifier (CID), see subclause 6.2;
- CC link identifier (CCLID), see subclause 6.3.

These parameters are transferred from the MF to the LEMF in:

- HI2: see subclause 8.4.1;
- HI3: see subclause 9.3.

6.5 Usage of Identifiers

The identifiers are exchanged between the mediation function and the LEMF via the interfaces HI1, HI2 and HI3. There exist several interface options for the exchange of information. Tables 1 and 2 define the usage of numbers and identifiers depending on these options.

NOTE: X in Table 1 and Table 2: Identifier used within parameters of the interface.

Table 1: Usage of identifiers, IRI and CC transmitted; options A, B: See subclause 10.4

Identifier	IRI and CC transmitted (option A)			IRI and CC transmitted (option B)		
	HI1	HI2	HI3	HI1	HI2	HI3
LIID	X	X	X	X	X	X
NID		X	X		X	X
CIN		X	X		X	X (see note 1)
CCLID					X	X (see note 2)

NOTE 1: The CIN of the 1st call for which this CC link has been set up.
NOTE 2: The CCLID may be omitted, see subclause 6.3.

Table 2: Usage of identifiers, only IRI or only CC transmitted

Identifier	Only IRI transmitted		Only CC transmitted	
	HI1	HI2	HI1	HI3
LIID	X	X	X	X
NID		X		X
CIN		X		X
CCLID				

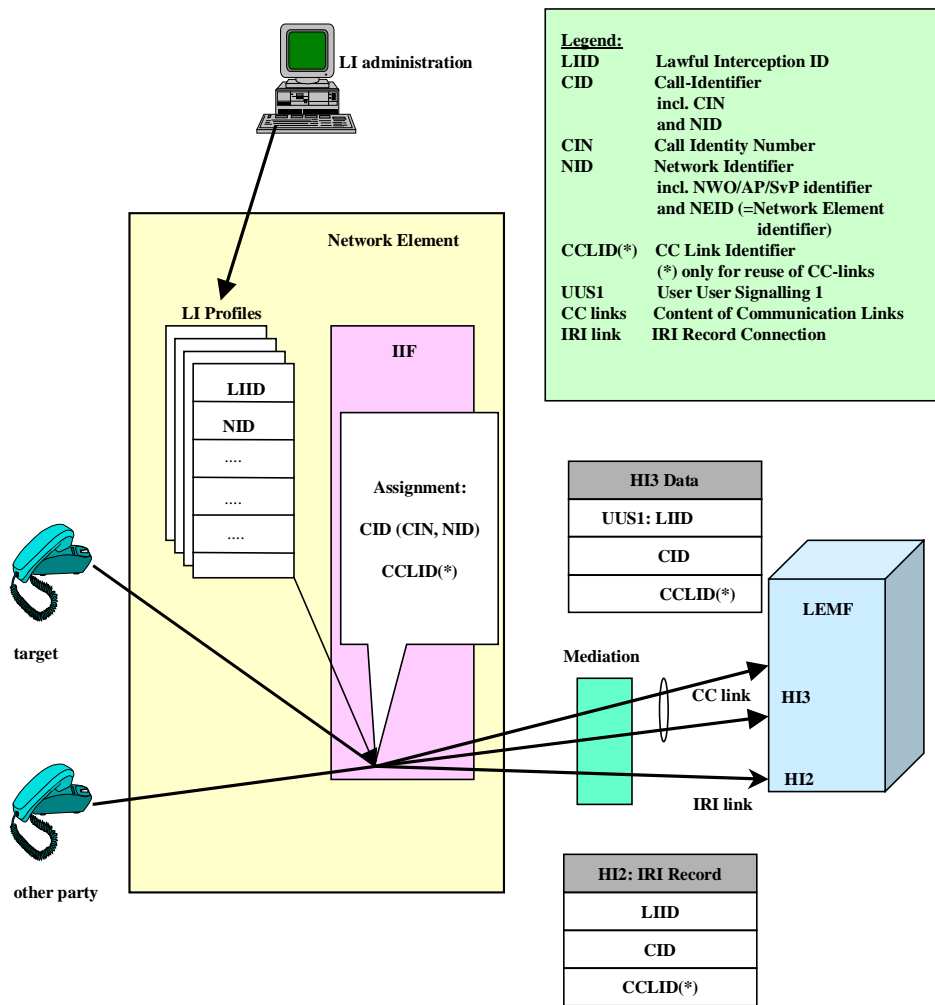

Figure 2: Overview of identifiers

7 HI1: Interface port for administrative information

The interface HI1 is typically bi-directional. It is used to hand over the requests for lawful interception to the NWO/AP/SvP, such as orders for activation, deactivation and modification, and the corresponding notifications, and send other information to the LEA.

There shall be no direct control over the NWO/AP/SvP's equipment by the LEMF.

7.1 Information for the activation of lawful interception

The HI1 interface may be realized as manual or electronic processing, see subclause 5.1.

If the LEA requests lawful interception, the NWO/AP/SvP needs a minimum set of information to activate lawful interception in the network.

The LEA shall provide the following information, for activation of LI:

- 1) Identification of the interception subject: Target identity.
- 2) The agreed lawful interception identifier (LIID).
- 3) Start and end (or duration) of the interception.
- 4) Further specification of type of interception:
 - kind of information to be provided (IRI, CC or both);
 - mode information (stereo / mono, see clause 9);
 - option A or B (reuse of CC links, see clause 10).
- 5) HI2 destination address of the LEMF, to which the IRI-Records shall be sent (if applicable).
- 6) HI3 destination address of the LEMF, to which the content of communication (CC) shall be sent (if applicable).
- 7) Other network dependent parameters (e.g. location information).

In addition, the following administrative information shall be included:

- 1) A reference for authorization of the interception.
- 2) Technical contact for issues relating to set-up and execution of the interception (e.g. solution of problems with communication links to the LEMF).

7.2 LI notifications towards the LEMF

LI management notifications to the LEMF shall be sent in the following cases:

- 1) After the activation of lawful interception.
- 2) After the deactivation of lawful interception.
- 3) After modification of an active lawful interception.
- 4) In case of certain exceptional situations.

For the definition of the information content of these LI management notifications, see clause A.4.

8 HI2: Interface port for intercept related information

The HI2 interface port shall be used to transport all intercept related information (IRI), i.e. the information or data associated with the telecommunication services of the target identity apparent to the network. It includes signalling information used to establish the telecommunication service and to control its progress, time stamps, and, if available, further information such as supplementary service information or location information. Only information, which is part of standard signalling procedures shall be used within call related IRI, see also subclause 5.2; i.e. if a CLI of an originating other party is not available, it need not be requested from the origin, by extra procedures (this fact is different from the principles normally applied, for example, for the malicious call identification service, MCID).

Sending of the intercept related information (IRI) to the LEMF shall in general take place as soon as possible, after the relevant information is available.

In exceptional cases (e.g. data link failure), the intercept related information may be buffered for later transmission for a specified period of time.

8.1 Data transmission link, protocol

The protocol used by the "LI application" for the encoding and the sending of data between the MF and the LEMF is based on ROSE components. ROSE (Remote Operation Service Element) is defined in the standards [35], [36] and [37].

This data communication method provides a general means of data communication between the LEA and the NWO/AP/SvP's mediation function. It is used for the delivery of:

- HI1 type of information (notifications, alarms, ...);
- HI2 type of information (IRI records);
- HI3 data type of information (UUS, SMS, IP frames, X.25 packets, ...).

The ROSE protocol provides a clean separation of these kinds of information at application level.

The present document specifies only the use of ROSE on the application layer and the BER on the presentation layer. The lower layers for data communication may be chosen in agreement with the NWO/AP/SvP and the LEA.

The delivery to the LEMF should use standard or widely used lower layer data communication protocols. Some examples for layers 1 to 3:

- Public X.25 network;
- ISDN B or D-channel (X.31 protocol);
- TCP/IP on Ethernet;
- TCP/IP on other network layer protocols (e.g. X.25).

Figure 3 illustrates the principle of the communication between the NWO/AP/SvP's HI2 mediation function (MF) and the LEA's LEMF (HI2 interface port).

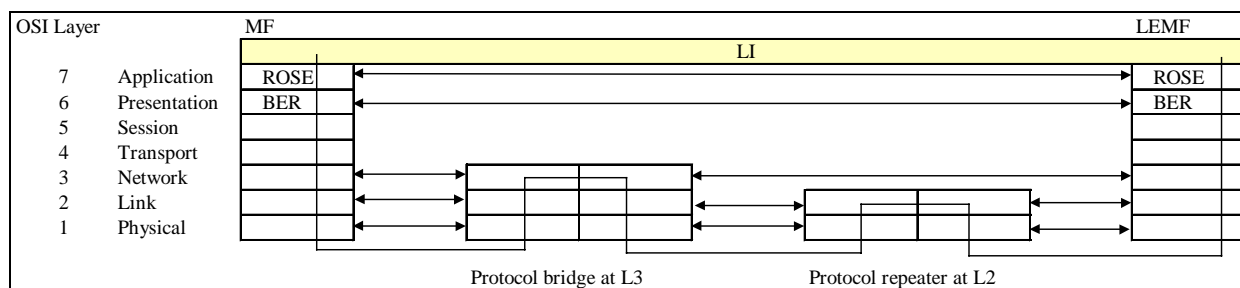

NOTE 1: A bridge between protocols has different network layer protocols on each side of the bridge.

NOTE 2: A repeater has the same network protocol on each side.

NOTE 3: The double headed arrows indicate peer relationships where each side has to be co-ordinated.

NOTE 4: The LI operation is independent of the protocols of intervening networks (indicated by the bridge and repeater).

Figure 3: Relation of LI application to OSI protocol stack

The MF and the LEMF are modeled as a pair of communicating entities that are separated by a number of intervening networks, which may use different communications hardware (e.g. 64 kbit/s circuit mode lines, TCP/IP packet networks, X.25 networks). ROSE, ASN.1 and BER provide a robust communications path between the two parts of the LI application.

8.1.1 Application for IRI (HI2 information)

As defined in subclause 5.2, the handover interface port 2 shall transport the intercept related information (IRI) from the NWO/AP/SvP's MF to the LEMF.

The individual IRI parameters shall be coded using ASN.1 and the basic encoding rules (BER). Where possible, the format of the information content shall be taken over from existing telecommunication standards, which are used for these parameters with the network already, like the ISDN user part, DSS1 and MAP. Within the ASN.1 coding for IRI, such standard parameters are typically defined as octet strings.

8.1.2 Application for LI notifications (HI1) and CC (HI3)

See subclauses 7.2 and 9.2, respectively.

8.2 Definition of intercept related information

Intercept related information will in principle be available in the following phases of a call:

- 1) At call attempt initiation when the target identity becomes active, at which time call destination information may or may not be available (set up phase of a call, target may be the originating or terminating party, or be involved indirectly by a supplementary service).
- 2) At the end of a call attempt, when the target identity becomes inactive (release phase of call).
- 3) At certain times between the above phases, when relevant information becomes available (active phase of call).

In addition, information on non-call related actions of a target constitutes IRI and is sent via HI2, e.g. information on subscriber controlled input.

The intercept related information (IRI) may be subdivided into the following categories:

- 1) Control information for HI2 (e.g. correlation information).
- 2) Basic call information, for standard calls between two parties.
- 3) Information related to supplementary services, which have been invoked during a call.
- 4) Information on non call related target actions.

8.3 Types of IRI records

Intercept related information shall be conveyed to the LEMF in messages, or IRI data records, respectively. Four types of IRI records are defined:

- | | |
|------------------------|--|
| 1) IRI-BEGIN record | at the first event of a call or service attempt, opening the IRI transaction |
| 2) IRI-END record | at the end of a call or service attempt, closing the IRI transaction |
| 3) IRI-CONTINUE record | at any time during a call or service attempt within the IRI transaction |
| 4) IRI-REPORT record | used in general for non call related events |

For information related to an existing call, the record types 1 to 3 shall be used. They form an IRI transaction for each call or call attempt, which corresponds directly to the sequence of the call (set-up, active phase, release).

Record type 4 is used for non call related subscriber action, like subscriber controlled input (SCI) for service activation. For simple calls, it can be applicable for unsuccessful call attempts.

The record type is an explicit part of the record. The 4 record types are defined independently of target call events. The actual indication of one or several call events, which caused the generation of an IRI record, is part of further parameters within the record's, information content. Consequently, the record types of the IRI transactions are not related to specific messages of the signalling protocols of a call, and are therefore independent of future enhancements of the intercepted services, of network specific features, etc. Any information on the target call state or other target call related information is contained within the information content of the IRI records.

8.4 Structure of IRI records

Each IRI-record contains several parameters. In the subclauses below, the usage of these parameters is explained in more detail.

Mandatory parameters are indicated as HI2 control information. Optional parameters are provided depending on the availability at the MF. For the internal structure of the IRI records, the ASN.1 description, with the application of the basic encoding rules (BER) is used. This ASN.1 specification is enclosed in Annex A.

8.4.1 Control information for HI2

The main purpose of this information is the unique identification of records related to a target identity, including their unique mapping to the links carrying the content of communication. In general, parameters of this category are mandatory, i.e. they have to be provided in any record.

The following items are identified (in brackets: ASN.1 name and reference to the ASN.1-definition or clause 6):

- 1) Record type (*IRIContent*, clause A.5)
IRI-BEGIN, IRI-CONTINUE, IRI-END, IRI-REPORT -record types.
- 2) Version indication (*version1*, see clause A.5)
Identification of the particular version of the HI2 interface specification.
- 3) Call Identifier (*CallIdentifier*, see subclause 6.2 and clause A.5).
- 4) Lawful Interception Identifier (*LawfulInterceptionIdentifier*, see subclause 6.1 and clause A.5).
- 5) Date & time (*TimeStamp*, clause A.5)
Date & time of record trigger condition.
The parameter shall have the capability to indicate whether the time information is given as Local time without time zone, GMT with time zone, or UTC. Normally, the NWO/AP/SvP shall define these options.
- 6) CC Link Identifier (*CC-Link-Identifier*, see subclause 6.2 and clause A.5).

Table 3 summarizes the items of HI2 control information. It is mandatory information, except the CID - it may be omitted for non call related IRI records - and the CCLID. Their format and coding definition is LI specific, i.e. not based on other signalling standards.

Table 3: Parameters for LI control information in IRI records (HI2 interface port)

IRI parameters: LI control information	
IRI parameter name	ASN.1 name (used in Annex A)
Type of record	<i>IRIContent</i>
Version indication	<i>version1</i>
Lawful Interception Identifier (LIID)	<i>LawfulInterceptionIdentifier</i>
Call identifier (CID) - Call Identity Number (CIN) - Network Identifier (NID)	<i>CallIdentifier</i>
date & time	<i>TimeStamp</i>
CC Link Identifier (CCLID) (only used in case of option B)	<i>CC-Link-Identifier</i>

8.4.2 Basic call information

This section defines parameters within IRI records for basic calls, i.e. calls, for which during their progress no supplementary services have been invoked. In general, the parameters are related to either the originating or terminating party of a call; consequently, ASN.1 containers are defined for the originating / terminating types of parties, which allow to include the relevant, party-related information. The structure of these containers, and the representation of individual items are defined in clause A.5.

NOTE: A third type of party information is defined for the forwarded-to-party (see subclause 8.4.3 on calls with supplementary services being invoked).

The items below are to be included, when they become available for the first time during a call in progress. If the same item appears identically several times during a call, it needs only to be transmitted once, e.g. in an IRI-BEGIN record. The ASN.1 name of the respective parameters, as defined in clause A.5, is indicated in brackets.

- 1) Direction of call (*Intercept_Call_Direct*)
Indication, whether the target identity is orig. or term. Party.
- 2) Address of originating and terminating parties (*CallingPartyNumber* or *CalledPartyNumber*)
If e.g. in case of call originated by the target at transmission of the IRI-BEGIN record only a partial terminating address is available, it shall be transmitted, the complete address shall follow, when available.
- 3) Basic Service, LLC (*Services-Information*)
Parameters as received from signalling protocol (e.g. BC, HLC, TMR, LLC).
- 4) Cause (*ISUP_parameters* or *DSS1_parameters_codeset_0*)
Reason for release of intercepted call. Cause value as received from signalling protocol. It is transmitted with the ASN.1 container of the party, which initiated the release; in case of a network initiated release, it may be either one.
- 5) Additional network parameters
E.g. location information (*Location*).

Parameters defined within Table 4 and Table 5 shall be used for existing services, in the given ETSI format. National extensions may be possible using the ASN.1 parameter *National-Parameters*.

8.4.3 Information on supplementary services, related to a call in progress

The general principle is, to transmit service related information within IRI records, when the corresponding event/information, which needs to be conveyed to the LEMF, is received from the signalling protocol. Where possible, the coding of the related information shall use the same formats as defined by standard signalling protocols.

The selection, which types of events or information elements are relevant for transmission to the LEAs is conforming to the requirements defined in [1] and [2].

A dedicated ASN.1 parameter is defined for supplementary services related to forwarding or re-routing calls (*forwarded-to-Party* information), due to the major relevance of these kind of services with respect to LI. For the various cases of forwarded calls, the information related to forwarding is included in the *originatingParty* / *terminatingParty* / *forwarded-to-Party* information:

- 1) If a call to the target has been previously forwarded, available parameters relating to the redirecting party(ies) are encapsulated within the *originatingPartyInformation* parameter.
- 2) If the call is forwarded at the target's access (conditional or unconditional forwarding towards the forwarded-to-party), parameters related to the redirecting party (target) are encapsulated within the *terminatingPartyInformation* parameter.
- 3) All parameters related to the forwarded-to-party or beyond the forwarded-to-party are encapsulated within the *forwarded-to-Party* ASN1 coded parameter. In addition, this parameter includes the *supplementary_Services_Information*, containing the forwarded-to address, and the redirection information parameter, with the reason of the call forwarding, the number of redirection, ...).

For the detailed specification of supplementary services related procedures see clause 10.

Parameters defined within Table 4 and Table 5 shall be used for existing services, in the given ETSI format. National extensions may be possible using the ASN.1 parameter *National-Parameters*.

8.4.4 Information on non call related supplementary services

The general principle is, to transmit non call related service information as received from the signalling protocol.

A typical user action to be reported is subscriber controlled input (SCI).

For the detailed specification of the related procedures see clause 10.

8.5 Selection of parameters for IRI records

Relevant information on a call is taken from the call handling process, using wherever possible the coding specifications of the standardized ISDN protocols, or other standard network protocols. The protocol-defined information content is copied transparently into the information elements of the IRI records. This principle enables to reuse of internationally agreed standardization results; it allows reuse of existing functions within the NWO/AP/SvP equipment and in the terminal area (LEMF).

Consequently, the present document needs for a large number of IRI-relevant items only to refer to other, existing standards, instead of including separate definitions in its scope. By this principle, also consistency issues and dependencies on the ongoing enhancements of the various protocols are minimized.

The relevant parameters are listed in Table 4 and Table 5.

For other signalling systems, which are not included in Table 4, the parameters shall be interpreted on a functional level, for defining their applicability in an IRI record; e.g. in case of a local call between analogue users, the *called party number* may only exist in an internal format of the switching system. Within the IRI records, such parameters shall also use the standardized coding. Existing interworking specifications, like [14] shall be used for the conversion to the standard format. If the signalling system provides less information than defined by the standards in Table 4, spare or default values may be used instead.

This method avoids the need to analyze for all situations, especially in the area of supplementary services, each detail of the service procedures, with specification of which parameter shall be sent in which state or situation. Instead, only a reference to the applicable standards is made. As soon as a parameter defined in one of the parameter tables appears within the target call protocol, it shall be transmitted within an IRI record.

In addition to parameters taken from the call handling process, further, lawful interception specific parameters are needed, like the control information for LI.

Three types of origins for the specification of HI2 parameters in IRI records can be differentiated:

- 1) Parameters for LI control information; they are specific for the LI HI2 interface, and are specified in the present document (Table 3).
- 2) Parameters used to convey information to the LEMF, which is retrieved from the target's call or service signalling protocol information (Table 4). Within the IRI a standardized protocol coding is used.

The relevant protocol specifications are the ISDN user part, as a generic protocol, used by several types of networks, and dedicated network protocols, e.g. DSS1 or GSM standards. For a common implementation in different countries and to guarantee the possibility of an interception measure across borders only parameters defined in ETSI standards shall be used.

- 3) Parameters used to convey information from events relating to the target call, but with no equivalent parameters being available in protocol standards. Such parameters shall be specified in the present document (Table 5).

The LI control information is a mandatory part of each IRI record (exception: CID), the information defined in Table 4 and Table 5 is included in IRI records, if the according parameter or event is detected during processing a call or a target identity related action.

Table 4: List of parameters from standard protocols, which may be contained in IRI records

IRI parameters: target call information, based on standard protocols			
IRI parameter name	name of ASN.1 parameter (of Annex A)	rel. standard	ref.
Three party conference invoke/result components (note 2)	PartyInformation / supplementary-Services-Information	DSS1	[20]
Add on conference invoke/result components (note 2)	PartyInformation / supplementary-Services-Information	DSS1	[19]
Bearer capability	PartyInformation / services-Information	DSS1	[6]
Call diversion information	PartyInformation / supplementary-Services-Info.	ISUP / DSS1	[5], [6]
Call transfer number	PartyInformation / supplementary-Services-Info.	ISUP	[5]
Called party number	PartyInformation / calledPartyNumber	ISUP / DSS1 / MAP	[5], [6], [32]
Called party subaddress	PartyInformation / supplementary-Services-Info.	DSS1	[10]
Calling party number	PartyInformation / callingPartyNumber	ISUP / DSS1	[5], [6]
Calling party subaddress	PartyInformation / supplementary-Services-Info.	DSS1	[10]
Cause indicator	release-Reason-Of-Intercepted-Call CallContentLinkCharacteristics	ISUP / DSS1	[5], [6]
Cell id	Location	MAP / ISUP	[32], [5]
Closed user group interlock code	PartyInformation / supplementary-Services-Info.	ISUP	[17]
Connected number	PartyInformation / supplementary-Services-Info.	ISUP / DSS1	[5], [6]
Connected subaddress	PartyInformation / supplementary-Services-Info.	DSS1	[10]
Explicit Call Transfer invoke/result components (note 2)	PartyInformation / supplementary-Services-Information	DSS1	[25]
Facility (note 3)	PartyInformation / supplementary-Services-Info.	DSS1	[29]
Generic notification indicator	PartyInformation / supplementary-Services-Info.	ISUP	[5]
Generic number	PartyInformation / supplementary-Services-Info.	ISUP	[5]
High layer compatibility	PartyInformation / services-Information	DSS1	[6]
IMEI	PartyInformation / imei	MAP	[32]
IMSI	PartyInformation / imsi	MAP	[32]
Keypad facility	PartyInformation / supplementary-Services-Info.	DSS1	[29]
Location number	Location	ISUP / MAP	[5], [32]
Low layer compatibility	PartyInformation / services-Information	DSS1	[6]
MCID response indicator	PartyInformation / services-Information	ISUP	[5]
Original called number	PartyInformation / supplementary-Services-Info.	ISUP / DSS1	[5], [6]
Redirecting number	PartyInformation / supplementary-Services-Info.	ISUP / DSS1	[5], [6]
Redirection information	PartyInformation / supplementary-Services-Info.	ISUP / DSS1	[5], [6]
Redirection number	PartyInformation / supplementary-Services-Info.	ISUP / DSS1	[5], [6]
Subaddress Transfer	PartyInformation / supplementary-Services-Info.	DSS1	[25]
Transmission Medium Reqmt.	PartyInformation / services-Information	ISUP	[5]
NOTE 1: Column "rel. standard" indicates the ETSI standard, which specifies the format and coding of the parameter.			
NOTE 2: Refers to several ASN.1 encoded elements, which are in the DSS1 protocol embedded in a Facility information element.			
NOTE 3: The Facility IE is only included, if it contains one or more of the parameters, which are part of this table.			

Table 5: List of LI specific parameters, which may be contained in IRI

IRI parameters. Target call information, LI specific definition	
IRI parameter name	ASN.1 name (used in Annex A)
direction of call	<i>intercept-Call-Direct</i>
call event (e.g.: answer indication call waiting indication hold indication retrieve indication suspend indication resume indication)	<i>SimpleIndication</i>
ringing duration	<i>RinglingDuration</i>
conversation duration	<i>ConversationDuration</i>
CC link information	<i>CallContentLinkInformation</i>
subscriber controlled input data	<i>DSS1-parameters-codeset-0, or sciData</i>
NOTE: Format and coding details see Annex A.	

The general principle is that, if parameters included in Table 4 are available, they shall be included in an IRI record, and be sent to the LEMF. Parameters of Table 5, which are not part of standard protocols, shall be included, when the according event or parameter, which needs to be reported to the LEMF is detected.

Parameters of Table 3 are present in all IRI records, except the call identifier: it may be missing in IRI-REPORT records; if no target call is related to it.

The list can be adapted to the requirements and feature specifications of a NWO/AP/SvP, and the laws and regulations of a country. That is, Table 4 and Table 5 may be extended nationally, or by a NWO/AP/SvP. Further in the present document, such extensions are referred to as national extensions or national parameters.

The IIF for IRI parameter generation may be seen as a kind of screening function, which watches the signalling information flow related to a target, and copies those information elements, which match with an element type in the screening lists, defined by Table 4 and Table 5.

The NWO/AP/SvP is not required to filter information out of the IRI.

An instance of the IIF for IRI generation needs in general not to store the information it has sent, or other information on a call, for the purpose to be aware of the status or context of a call. Each IRI parameter is independent from previous or future parameters. Exceptions from this general principle can exist, e.g. in order to avoid multiple transmission of the same information. However, there is no requirement, to suppress multiple sending of the same information, in different IRI records.

As it is indicated in Table 4, for a given logical parameter different format types may be used, depending on the type of network, and the call configuration. If a parameter is specified in the ISDN user part, and also identically in other standards, only the ISDN user part is referenced.

8.6 Coding of parameters in IRI records

The parameters shall be included in the IRI records in a structured way. The structure is defined using ASN.1, the individual parameters are in terms of the ASN.1 notation octet strings, which are taken over from the applicable standards. The ASN.1 detailed coding specification is described in Annex A.

In case of the delivery of the IRI records to a LEA, network specific extensions, the network specific parameters are transmitted as defined by the sending network.

8.7 Information content of the IRI record types

In principle, no restriction is made on which parameters shall or may be present in which IRI record type, except for the mandatory parameters, which are needed in all records. However, the logical information flow of calls implies, that certain parameters will normally not appear in specific records; e.g. a called party number parameter is not included in an IRI-END record, because it has been transmitted earlier already.

9 HI3: Interface port for content of communication

The port HI3 shall transport the content of the communication (CC) of the intercepted telecommunication service to the LEMF. The content of communication shall be presented as a transparent en-clair copy of the information flow during an established, frequently bi-directional, communication of the interception subject. It may contain voice or data. A target call has two directions of transmission associated with it, to the target, and from the target. Two communication channels to the LEMF may be needed for transmission of the content of communication (stereo transmission).

For speech signals, as a network option, the two target communication directions can be combined (summed, mono transmission), thus requiring only one channel for the content; the quality of service is reduced, especially the unambiguous information on the source of the signal gets lost. For services, which are not "speech", the stereo mode should be used. Whether or not the mono mode is used for a specific surveillance, shall be selectable at its activation or modification. See Figure 4 and Figure 5 for illustration of the stereo and mono modes, respectively.

The network does not record or store the content of communication.

9.1 Delivery of circuit switched content of communication

The transmission media used to support the HI3 port shall be standard ISDN calls, based on 64 kbit/s circuit switched bearer connections. The CC links are set up on demand to the LEMF. The LEMF constitutes an ISDN DSS1 user function, with an ISDN DSS1 basic or primary rate access. It may be locally connected to the target switching node, or it may be located somewhere in the target network or in another network, with or without a transit network in between. For network signalling, the standard ISDN user part shall be used. No modifications of the existing ISDN protocols shall be required. Any information needed for LI, like to enable correlation with the IRI records of a call, can be inserted in the existing messages and parameters, without the need to extend the ETSI standard protocols for the LI application.

For each LI activation, a fixed LEMF address is assigned; this address is, within the present document, not used for any identification purposes; identification and correlation of the CC links is performed by separate, LI specific information, see clause 6.

The functions defined in the ISDN user part standard, Version 1 (ETSI ISUP V1) are required as a minimum within the target network and, if applicable, the destination and transit networks, especially for the support of:

- Correlation of HI3 information to the other HI port's information, using the supplementary service user-to-user signalling 1 implicit (UUS1).
- Access verification of the delivery call (see clause 13).

The bearer capability used for the CC links is 64 kbit/s unrestricted digital information; this type guarantees that the information is passed transparently to the LEMF. No specific HLC parameter value is required.

The CC communication channel is a one-way connection, from the NWO/AP/SvP's IIF to the LEMF, the opposite direction is not switched through in the switching node of the target.

The scenario for delivery of the content of communication is as follows:

- 1) At call attempt initiation, for one 64 kbit/s bi-directional target call and stereo delivery, two ISDN delivery calls are established from the MF to the LEMF. One call offers the content of communication towards the target identity (CC R_x call/channel), the other call offers the content of communication from the target identity (CC T_x call/channel). See Figure 4.
- 2) At call attempt initiation, for one 64 kbit/s bi-directional target call and mono delivery, one ISDN delivery call is established from the MF to the LEMF. This call offers the summed content of communication towards the target identity (CC R_x call) and from the target identity (CC T_x call). See Figure 5.
- 3) During the establishment of each of these calls, appropriate checks are made (see clause 13).
- 4) The MF passes during call set up, within the signalling protocol elements of the CC link the LIID and the CID to the LEMF. The LEMF uses this information to identify the target identity and to correlate between the IRI and CC (see subclause 9.3).
- 5) At the end of a call attempt, each delivery call associated with that call attempt shall be released by the MF.

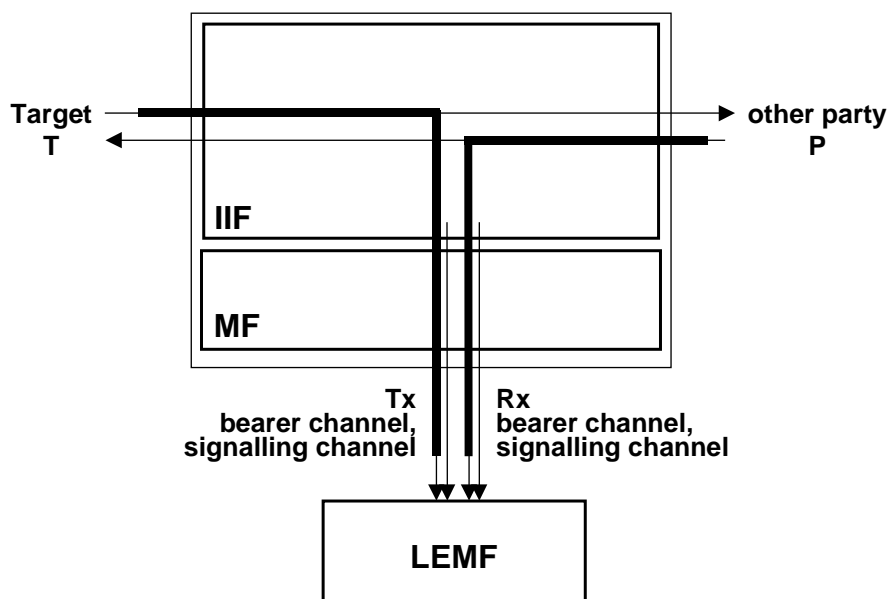

Figure 4: Content of communication transmission from MF to LEMF, stereo mode

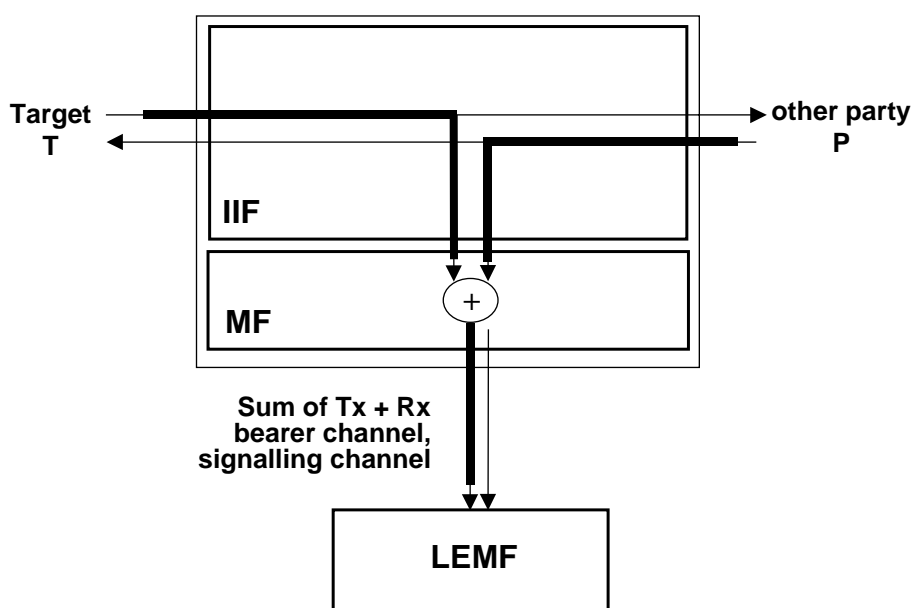

Figure 5: Content of communication transmission from MF to LEMF, mono mode

9.2 Delivery of packetized content of communication (general)

For packetized content of communication, the same physical link as used for HI2, or a dedicated link may be used. The ROSE operations for the transmission of the content of communication (HI3 data interface) shall follow the same rules as the one defined for the HI2 interface in subclause 8.1.

A differentiation is made between:

- 1) bearer related or bearer unrelated end user information; and
- 2) packet switched data services (for further study).

The first type, end user information, comprises services like SMS and UUS; typically, the average data rates during invocation of these services are low, in the range of a few bytes per second. Using the same data link as for HI2 information will in general cause an additional load.

NOTE: Exceptionally, for the GSM SMS service, this information may be passed via HI2.

9.3 Control information for HI3

9.3.1 Circuit switched content of communication

The delivery calls shall use unmodified standard ISDN protocols (DSS1, ISDN user part). The table below summarizes specific settings of parameters for the CC links. The User-to-User service 1 parameter is used during call set up (within the ISUP Initial Address Message [5] or DSS1 Set Up Message [6], respectively) to transmit LI-specific control information. This information is carried transparently and delivered to the specific LEMF remote user.

To identify the delivered information, including correlating the delivery calls with the IRI records, parameters 1 to 3 and 5 shall be included in the call set up. Parameters 6 to 9 specify settings of further relevant information. Other parameters of the ISDN protocols shall correspond to normal basic calls.

Table 6: Definition of HI3 specific signalling information; UUS1 coding details: See clause A.9

No.	Used information element of CC link signalling protocol	Information	Purpose
1	CLI-Parameter with attribute "network provided"	See clause 13	LEMf can check identity of origin of call.
2	UUS1 - parameter	lawful interception identifier (LIID); see clause 6	Identifier, identifying target identity
3	UUS1 - parameter	call identifier (CID), see clause 6	Identifier, identifying specific call of target identity
4	UUS1 - parameter	CC link identifier (CCLID), if required; see clause 6	Identifier, used for correlation CC link - IRI records
5	UUS1 - parameter	Direction indication (communication from / towards target / combined (mono))	Signal from (T _x) / towards (R _x) target identity or combined
6	UUS1 - parameter	bearer capability of target call	(optional)
7	closed user group interlock code	closed user group interlock code	Supplementary Service CUG Security measure at set up of the CC link
8	basic service (BS)	basic service (BS) of CC link: 64 kbit/s unrestricted	Guarantee transparent transmission of CC copy from MF to LEMF
9	ISDN user part forward call indicators parameter	ISDN user part preference indicator: "ISDN user part required all the way"	Guarantee transparent transmission of UUS1 and other supplementary services information

Parameters 2, 3 and 4 are also present in the IRI records, for correlation with the CC links. Parameter 5 indicates in case of separate transmission of each communication direction, which part is carried by a CC link. Parameter 6, the basic service of the target call, can be used by the LEMF for processing of the CC signal, e.g. to apply compression methods for speech signals, in order to save storage space. Parameter 7 contains the CUG of the LEA. It is optionally used at set up the CC link to the LEA. Parameter 8, the basic service of the CC link, is set to "64 kbit/s unrestricted": All information of the R_x, T_x channels can be transmitted fully transparently to the LEA. The setting of the ISDN user part indicator guarantees, that the services supporting the LI CC link delivery are available for the complete CC link connection.

The MF uses en-bloc dialling, i.e. there exists only one message in forward direction to the LEA.

NOTE: The LEMF should at reception of the set up message not use the alerting state, it should connect immediately, to minimize time delay until switching through the CC links.

The maximum length of the user information parameter can be more than the minimum length of 35 octets (national option, see [5]), i.e. the network transmitting the CC links shall support the standard maximum size of 131 octets for the UUS1 parameter.

The User-to-User service 1 parameter cannot be discarded by the ETSI ISUP procedures: The only reason, which would allow the ISUP procedures to discard it would be, if the maximum length of the message carrying UUS1 would be exceeded. With the specified amount of services used for the CC links, this cannot happen.

The signalling messages of the two CC channels (stereo mode) carry the same parameter values, except for the direction indication.

See clause A.9 for the ASN.1 definition of the UUS1 LI specific content of the UUS1 parameter.

9.3.2 Packetized content of communication

For the transmission of packetized content of communication (end user information, see subclause 9.2, type 1), the same identifiers as for HI2 shall be used. These are firstly the LIID (identifying the target, and the LI authorization), and secondly the CID.

10 LI procedures for circuit switched supplementary services

10.1 General

In general, LI shall be possible for all connections and activities in which the target is involved. The target shall not be able to distinguish alterations in the offered service. It shall also not be possible to prevent interception by invoking supplementary services. Consequently, from a supplementary services viewpoint, the status of interactions with LI is "no impact", i.e. the behaviour of supplementary services shall not be influenced by interception.

Depending on the type of supplementary service, additional CC links to the LEA may be required, in addition to already existing CC links.

Within the IRI records, the transmission of additional, supplementary service specific data may be required.

Supplementary services, which have an impact on LI, with respect to CC links or IRI record content, are shown in Table 7 below. The table is based on ISDN services (DSS1 protocol specifications), it considers the services which have been standardized at the time of finalizing the present document. Future services should be treated following the same principles.

NOTE 1: Co-ordination of handling of new services should be performed via ETSI TC SEC. If required, additions will be included in a subsequent version of the present document.

Services defined for other signalling protocols, which can be related to the services in the table shall be treated in the same manner (see also below). Other protocols are e.g.:

- Analogue user signalling; in general, no ETSI standards are available for supplementary services.
- Mobile user protocols of the GSM, defined within the MAP [32].

The question of Lawful Interception with Intelligent Networks is for further study (see note 2 below).

NOTE 2: The general principle is, that LI takes place on the basis of a technical identity, i.e. a directory number. Only numbers which are known to the NWO/AP/SvP, and for which LI has been activated in the standard way, can be intercepted. No standardized functions are available yet which would enable an SCF to request from the SSF the invocation of LI for a call.

Additional CC links are only required, if the target is the served user. IRI Records may also carry data from other parties being served users.

Annex B specifies details for relevant services:

- The procedures for CC links, depending on the call scenario of the target.
- Related to the IRI records, the point in time of sending and supplementary service specific information.
- Additional remarks for services with "no impact" on LI.

The specifications for supplementary services interactions are kept as far as possible independent of the details of the used signalling protocols; service related events are therefore described in more general terms, rather than using protocol dependent messages or parameters.

Interactions with services of the same family, like call diversion services, are commonly specified, if the individual services behaviour is identical, with respect to LI.

With respect to the IRI records, Annex B specifies typical cases; the general rules for data which shall be included in IRI records are defined in clause 8, specifically in subclause 8.5, and subclause 10.3 below.

Services which are not part of the Table 7 do not require the generation of LI information: No CC links are generated or modified, and no specific information on the service is present in the IRI records. That is, these services have "no impact" on LI, no special functions for LI are required. However, within the IIF, functions may be required to realize the principle, that the service behaviour shall not be influenced by LI.

"No impact" is not automatically applicable for new services. Each new service has to be checked for its impact on LI. Additionally, also services using other than the DSS1 protocols, which cannot be related to one of the DSS1 based services, may have impact on LI.

The present document does not intend to give a complete description of all possible cases and access types of interactions with supplementary services.

10.2 CC link Impact

The column "CC links: additional calls, impact" (Table 7) defines, whether:

- for the related service CC links shall be set up, in addition to the CC links for a basic call;
- already existing calls are impacted, for example by disconnecting their information flow.

The CC link impact relates always to actions of a target being the served user. Services invoked by other parties have no CC link impact.

10.3 IRI Impact, General Principle for Sending IRI records

The column "IRI items related to service" (Table 7) specifies, which parameters may be transmitted to the LEA within the IRI records. For several services, it is differentiated, whether the target or the other party is the served user (underlined in table).

The table specifies, which parameters are applicable in principle. That is, these parameters are normally sent to the LEA, immediately when they are available from the protocol procedures of the service. In many cases, additional IRI-CONTINUE records, compared to a basic call, will be generated. However, not each service related signalling event needs to be sent immediately within an individual record. Exceptions may exist, where several events are included in one record, even if this would result in some delay of reporting an event (this may be implementation dependent). Each record shall contain all information, which is required by the LEA to enable the interpretation of an action; example: the indication of call forwarding by the target shall include the forwarded-to number and the indication of the type of forwarding within the same record.

The complete set of parameters, which are applicable for IRI, is specified in subclause 8.5 (Table 4 and Table 5).

If during procedures involving supplementary services protocol parameters, which are listed in Table 4 and Table 5 become available, they shall be included in IRI Records. This rule is directly applicable for parameters received via ISUP and DSS1 signalling protocols. Regarding all other protocols, e.g. of analogue users, the mapping to the ISDN protocols, as defined in subclause 8.5 is assumed, before discriminating, which (mapped) parameters are copied to the IRI records. For parameters of ETSI-standardized services, like GSM services, which cannot be mapped to ISUP parameters, the specific coding, e.g. of the MAP [32] may be used, instead of mapping the information to DSS1 parameters.

IRI data are not stored by the IIF or MF for the purpose of keeping information on call context or call configuration, including complex multiparty calls. The LEMF (electronically) or the LEA's agent (manually) shall always be able, to find out the relevant history on the call configuration, to the extent, which is given by the available signalling protocol based information, within the telecommunication network.

Service invocations, which result in invoke and return result components (as defined in Table 4) need only be reported in case of successful invocations. One IRI record, containing the invoke component, possibly including additional parameters from the return result component, is sufficient. Instead of the DSS1 functional protocol components, for specific networks other ETSI-standardized components may be used, e.g. of the MAP [32].

With respect to the inclusion of LI specific parameters, see also the parameter specifications and example scenarios in Annex E for more details.

Details of e.g. the definition of the used record type, their content, the exact points in time of sending etc. follow from the according service specifications; in some cases, they are specified explicitly in the normative Annex B and in the informative Annex E.

10.4 Multi party calls - general principles, options A, B

With respect to IRI, each call or call leg owns a separate IRI transaction sequence, independent of whether it is actually active or not.

With respect to the CC links, two options (A, B) exist, which depend on laws, regulations and LEA requirements, see below. Active call or call leg means in this context, that the target is actually in communication with the other party of that call or call leg; this definition differs from the definition in [6].

10.4.1 CC links for active and non-active calls (option A)

For each call, active or not, separate CC links shall be provided. This guarantees, that:

- changes in the call configuration of the target are reflected immediately, with no delay, at the LEMF;
- the signal from held parties can still be intercepted.

It is a network option, whether the communication direction of a non-active call, which still carries a signal from the other party, is switched through to the LEMF, or switched off.

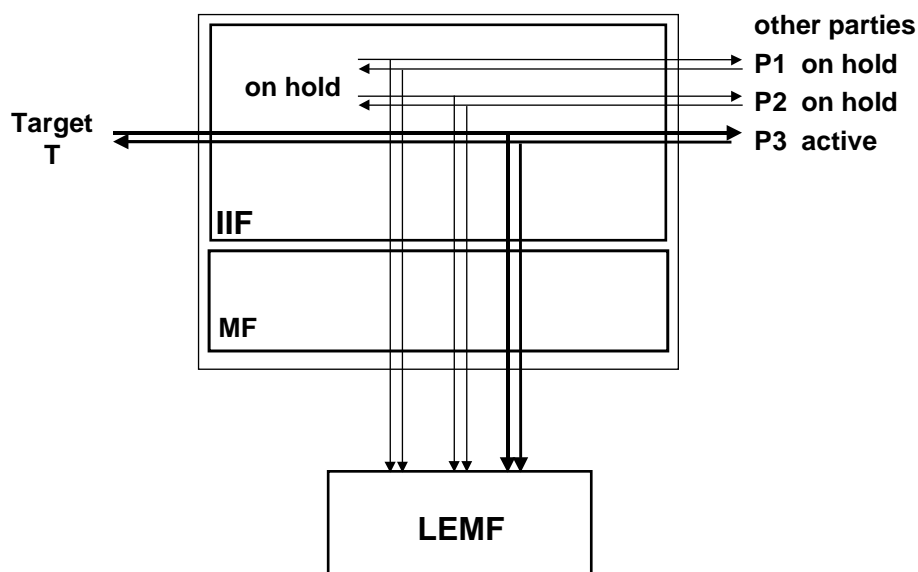

Figure 6: CC link option A (example for call hold supplementary service)

10.4.2 Reuse of CC links for active calls (option B)

CC links are only used for calls active in their communication phase. Changes in the call configuration may not be reflected at the LEMF immediately, because switching in the IIF/MF is required, and the signal from the held party is not available.

Each time, another target call leg uses an existing CC link, an IRI-CONTINUE record with the correct CID and CCLID shall be sent.

NOTE: Even when option B is used, more than one CC link may be required simultaneously.

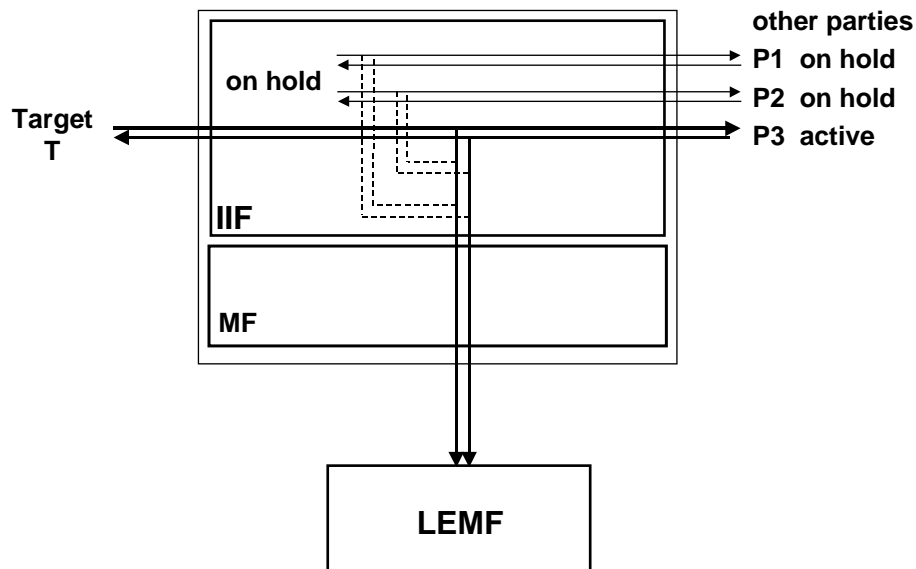

Figure 7: CC link option B (example for call hold supplementary service)

10.5 Subscriber Controlled Input (SCI): Activation / Deactivation / Interrogation of Services

For user procedures for control of Supplementary Services (Activation / Deactivation / Interrogation), a special IRI record type (IRI-REPORT record) is defined to transmit the required information.

If the DSS1 Functional Protocol [29] is used by the target, the functional information elements, usually ASN.1 encoded, are copied to the IRI-REPORT record as received by the target exchange. In case of analogue targets or use of the ISDN keypad protocol [39] (digits or IA5-characters), other appropriate parameters identifying the services are used. They may consist of the string sent by the user, or system-specific parameters, which identify the service sufficiently.

The IRI-REPORT record shall contain an indicator, whether the request of the target has been processed successfully or not.

At the exchange, where the subscriber data of a target shall be modified via a remote control procedure, an IRI-REPORT record shall be generated as if the control procedure had taken place locally.

Table 7: Suppl. Services with impact on LI CC links or IRI records content; see also Annex B

Suppl. Service	Abbr.	CC links: additional calls, impact	IRI items related to service
Call Waiting	CW	CC links for active or all calls (option A/B)	target: call waiting indication, calling party address other party: generic notification indicator
Call Hold	HOLD	CC links for active or all calls (option A/B)	target: call hold indication other party: generic notification indicator
Call Retrieve	RETRIEVE	CC links for active or all calls (option A/B)	target: call retrieve indication other party: generic notification indicator
Explicit Call Transfer	ECT	Before transfer: see HOLD. After transfer: LI may or may not be stopped	target: components of Facility IE other party: generic notification indicator
Terminal Portability	TP	No impact on CC links	target: call suspend / resume indications other party: generic notification indicator
Subaddressing	SUB	No impact on CC links	Subaddress IE, as available (calling, called, ...)
Calling Line Identification Presentation	CLIP	No impact on CC links	CLI parameter: part of <i>originating-Party information</i>
Calling Line Identification Restriction	CLIR	No impact on CC links	restriction indicator is part of CLI parameter
Connected Line Identification Presentation	COLP	No impact on CC links	COL parameter: part of <i>terminating-Party information</i>
Connected Line Identification Restriction	COLR	No impact on CC links	restriction indicator is part of COL parameter
Closed User Group	CUG	No impact on CC links	CUG interlock code
Add On Conference	CONF	T _x : signal from target; R _x call sum signal CC links depending on option A/B.	target: components of Facility IE other party: generic notification indicator
Three Party Conference	3PTY	Initially: held and active calls see HOLD., Conf.: See CONF.	target: components of Facility IE other party: generic notification indicator
Call Forwarding Unconditional; see note below	CFU	1 CC link for each call, which is forwarded by the target. Forwarding by other parties: no impact.	target: See 8.4.3, point 2, 3. ; if redirecting no.=target DN: not included. Other party (call to target is a forwarded call): See 8.4.3, point 1. Other party (call from target gets forwarded): See 8.4.3, point 3.
Call Forwarding No Reply; see note below	CFNR	1. basic call with standards CC links, released after time-out (incl. CC links) 2. forwarding: same as CFU	1. basic call, released after time-out, standard IRI 2. forwarding: same parameters as for CFU
Call Forwarding Busy; see note	CFB	Network determined user busy: see CFU. User determined user busy: see CFNR	network determined user busy: see CFU. user determined user busy: see CFNR
Call Deflection	CD	See CFNR.	See CFNR
Partial Rerouting	PR	See CFNR.	See CFNR
Malicious Call Identification	MCID	No impact on CC links	MCID response indicator sent at invocation
User-to-User Signalling 1,2,3	UUS	No impact on CC links	user-to-user information, more data IE (part of HI3 information, see clause A.6)
Fallback procedure (not a suppl. serv.)	FB	No impact on CC links	target or other party: new basic service IE
NOTE: Other variants of Call Forwarding, like Forwarding to fixed numbers, to information services etc. are assumed to be covered by the listed services.			

11 Performance & quality

11.1 Timing

As a general principle, within a telecommunication system, intercept related information (IRI), if buffered, should be buffered for as short a time as possible.

NOTE: If the transmission of intercept related information fails, it may be buffered or lost.

11.2 Quality

The quality of service associated with the result of interception should be (at least) equal to the quality of service of the original content of communication.

12 Exception handling

12.1 Failure of CC links

If a CC link cannot be set up, a certain number of repeat attempts during a certain period of time shall be made.

NOTE: Typical values are 3 tries during 10 seconds.

In case of a delay or total failure to transmit the content of communication, the following network depending options exist:

- 1) The target call is handled fully independent of the CC link, the CC information gets lost.
- 2) The target call set up is delayed, until the CC link is available; the delay is limited, if the limit is exceeded, the target call is set up.

12.2 Failure of ROSE protocol stack

For further study.

12.3 Fault reporting

For several events the target switching function sends messages to the NWO/AP/SvP administration centre. Some example events are given in the table below.

Alternatively, all or some of these events may be transmitted directly to the LEMF. In this case, they are part of the LI management notification type of information.

Delivery to the NWO/AP/SvP administration centre is not part of the HI.

Table 8: Typical events causing messages

Event Type	Event causing message with LI alarm information
Administration	LI subscriber deleted
	Bulk modification of subscriber numbers
	Individual modification of LI subscriber number
	New ISDN MSN creation
Exchange General	LI database lost (e.g. software reload for recovery purposes)
CC link failure	No answer from LEA
	LEA is busy
	CC link failed due to a COLP error
	CC link failed due to a CUG error
	CC link set up failure within the network
	CC link failed due to a lack of system resources
	General CC link set up failure

12.4 Handling of Unrecognized Fields and Parameters

During decoding of a record at the LEA, the following exceptional situations may occur:

- 1) Unrecognized parameter: The parameter layout can be recognized, but its name is not recognized:
The parameter shall be ignored, the processing of the record proceeds.
- 2) The parameter content or value is not recognized or not allowed:
The parameter shall be ignored, the processing of the record proceeds.
- 3) The record cannot be decoded (e.g. it seems to be corrupted):
The whole record shall be ignored.

NOTE: In cases 2 and 3, the LEMF may wish to raise an alarm to the NWO/AP/SvP administration centre. For case 1, no special error or alarm procedures need be started at the LEA, because the reason may be the introduction of a new version of the specification in the network, not be an error as such security aspects.

13 Security aspects

In any individual case the national security requirements should be met.

13.1 Security requirements at the interface port HI1

Since HI1 is not defined yet, this is for further study.

13.2 Security requirements at the interface port HI2

If using X.25 for the delivery of the IRI records an X.25-CUG should be installed to ensure confidentiality.

13.3 Security requirements at the interface port HI3

The process of access verification and additional (optional) authentication between the MF and the LEMF shall not delay the set up of the CC.

For the protection and access verification of the content of communication delivery call the ISDN supplementary services CLIP, COLP and CUG shall be used.

Generally any authentication shall be processed before the setup of the CC links between the MF and the LEMF is completed. If this is technically not feasible the authentication may be processed after completion of the CC connection in parallel to the existing connection.

13.3.1 LI access verification

The supplementary service CLIP shall be used to check for the correct origin of the delivery call.

NOTE: When using CLIP, the supplementary service CLIR must not be used.

The supplementary service COLP shall be used to ensure that only the intended terminal on the LEA's side accepts incoming calls from the handover interface (HI).

To ensure access verification the following two checks shall be performed:

- check of calling-line identification presentation (CLIP) at the LEMF; and
- check of connected-line identification presentation (COLP) at the handover interface (HI).

13.3.2 Access protection

In order to prevent faulty connections to the LEA, the CC links may be set up as CUG calls.

In this case, the following settings of the CUG parameters should be used:

- Incoming Access: not allowed;
- Outgoing Access: not allowed;
- Incoming calls barred within a CUG: no;
- Outgoing calls barred within a CUG: yes.

13.3.3 Authentication

In addition to the minimum access verification mechanisms described above, optional authentication mechanisms according to the standard series ISO 9798 "Information technology - Entity authentication - parts 1 to 5" may be used.

These mechanisms shall only be used in addition to the access verification and protection mechanisms.

14 Quantitative aspects

See [2]. The number of targets based on a percentage of subscribers should be provided at a national level together with an indication as to the expected usage.

Annex A (normative): Operation for sending of data across the HI interface

This annex specifies the coding details at the handover interface HI for all data records, which may be sent from the NWO/AP/SvP's equipment to the LEMF, across HI.

At the 3 handover interface ports, the following data records may be present:

- interface port HI1: Interception configuration information (ICI) records;
- interface port HI2: Interception related information (IRI) records;
- interface port HI3: records containing message-based user information.

The detailed coding specification for these types of information is contained in this annex, including sufficient details for a consistent implementation in the NWO/AP/SvP's equipment and the LEMF.

A.1 Syntax definitions

The transferred information and messages are encoded to be binary compatible with [33] (Abstract Syntax Notation One (ASN.1)) and [34] (Basic Encoding Rules (BER)).

These recommendations use precise definitions of the words *type*, *class*, *value*, and *parameter*. Those definitions are paraphrased below for clarity.

A *type*, in the context of the abstract syntax or transfer syntax, is a set of all possible values. For example, an INTEGER is a type for all negative and positive integers.

A *class*, in the context of the abstract syntax or transfer syntax, is a one of four possible domains for uniquely defining a type. The classes defined by ASN.1 and BER are: UNIVERSAL, APPLICATION, CONTEXT, and PRIVATE.

The UNIVERSAL class is reserved for international standards such as [33] and [34]. Most parameter type identifiers in the HI ROSE operations are encoded as CONTEXT specific class. Users of the protocol may extend the syntax with PRIVATE class parameters without conflict with the present document, but risk conflict with other users' extensions. APPLICATION class parameters are reserved for future extensions.

A *value* is a particular instance of a type. For example, five (5) is a possible value of the type INTEGER.

A *parameter* in the present document is a particular instance of the transfer syntax to transport a value consisting of a tag to identify the parameter type, a length to specify the number of octets in the value, and the value.

In the BER a *tag* (a particular type and class identifier) may either be a primitive or a constructor. A *primitive* is a pre-defined type (of class UNIVERSAL) and a *constructor* consists of other types (primitives or other constructors). A constructor type may either be IMPLICIT or EXPLICIT. An IMPLICIT type is encoded with the constructor identifier alone. Both ends of a communication must understand the underlying structure of the IMPLICIT types. EXPLICIT types are encoded with the identifiers of all the contained types. For example, an IMPLICIT Number of type INTEGER would be tagged only with the *Number* tag, where an EXPLICIT number of type INTEGER would have the *INTEGER* tag within the *Number* tag. The present document uses IMPLICIT tagging for more compact message encoding.

For the coding of the value part of each parameter the general rule is to use a widely use a standardized format when it exists (ISUP, DSS1, MAP, ...).

As a large part of the information exchanged between the user's may be transmitted within ISUP/DSS1 signalling, the using of the coding defined for this signalling guarantee the integrity of the information provided to the LEMF and the evolution of the interface. For example if new values are used within existing ISUP parameters, this new values shall be transmitted transparently toward the LEMF.

A.2 Object tree

Table A.1: ASN.1 description of security object tree

SecurityDomainDefinitions { ccitt (0) identified-organization (4) etsi (0) securityDomain (2)}

```

DEFINITIONS IMPLICIT TAGS ::=
BEGIN
-- Security DomainId
securityDomainId OBJECT IDENTIFIER ::= { ccitt (0) identified-organization (4) etsi (0)
securityDomain (2)}

-- Security Subdomains
fraudSubDomainId OBJECT IDENTIFIER ::= {securityDomainId fraud (1)}
lawfulInterceptSubDomainId OBJECT IDENTIFIER ::= {securityDomainId lawfulIntercept (2)}

-- LawfulIntercept Subdomains
hi1DomainId OBJECT IDENTIFIER ::= {lawfulInterceptSubDomainId hi1 (0)}
hi2DomainId OBJECT IDENTIFIER ::= {lawfulInterceptSubDomainId hi2 (1)}
-- See table A.4

hi3DomainId OBJECT IDENTIFIER ::= {lawfulInterceptSubDomainId hi3 (2)}
himDomainId OBJECT IDENTIFIER ::= {lawfulInterceptSubDomainId him (3)}
-- See table A.2

-- HI1 Subdomains
hi1NotificationOperations OBJECT IDENTIFIER ::= {hi1DomainId notificationOperations (1)}
-- See table A.3

-- HI3 Subdomains
hi3CircuitLISubDomainId OBJECT IDENTIFIER ::= {hi3DomainId circuitLI (1)}
-- See table A.5

hi3TETRALISubDomainId OBJECT IDENTIFIER ::= {hi3DomainId tETRALI (2)}
-- For further study
-- See table A.6

hi3GPRSLISubDomainId OBJECT IDENTIFIER ::= {hi3DomainId gPRSLI (3)}
-- For further study
-- See table A.7

hi3CCLinkLISubDomainId OBJECT IDENTIFIER ::= {hi3DomainId circuitLI (4)}
-- See table A.8
END -- SecurityDomainDefinitions

```

A.3 HI management operation

Table A.2: ASN.1 description of HI management operation (any HI interface)

HIManagementOperations { ccitt (0) identified-organization (4) etsi (0) securityDomain (2) lawfulIntercept (2) him (3) version1 (1)}

```

DEFINITIONS IMPLICIT TAGS ::=
BEGIN
EXPORTS Sending-of-Password, Data-Link-Test, End-Of-Connection ;

IMPORTS OPERATION, ERROR FROM Remote-Operations-Information-Objects
{joint-iso-ITU-T remote-operations(4) informationObjects(5) version1(0)notation (0)};

IMPORTS himDomainId
FROM SecurityDomainDefinitions { ccitt (0) identified-organization (4) etsi (0) securityDomain (2)}

Sending-of-Password OPERATION
ARGUMENT Password-Name
RESULT
ERROR
CODE globalValue { himDomainId sending-of-Pasword (1) version1 (1)}
-- Class 2 operation . The timer must be set to a value between 3 s and 240s. The timer default
value is 60s.

Data-Link-Test OPERATION
ARGUMENT
RESULT
ERROR
::= globalValue { himDomainId data-link-test (2) version1 (1)}

```

```

-- Class 2 operation . The timer must be set to a value between 3s and 240s. The timer default value
is 60s.

    End-Of-Connection    OPERATION
                        ARGUMENT
                        RESULT
                        ERROR
                        ::= globalValue { himDomainId end-of-connection (3) version1 (1)}
-- Class 2 operation . The timer must be set to a value between 3s and 240s. The timer default value
is 60s.

Password-Name      ::= SEQUENCE {
    Password    [1] OCTET STRING (SIZE (1..25)),
    name        [2] OCTET STRING (SIZE (1..25)),
    ...}

    -- IA5 string recommended
END -- HIManagementOperations

```

A.4 LI management notification

Table A.3: ASN.1 description of LI management notification operation (HI1 Interface)

HI1NotificationOperations { ccitt (0) identified-organization (4) etsi (0) securityDomain (2) lawfulIntercept (2) hi1 (0) notificationOperations (1) version1 (1)}

```

DEFINITIONS IMPLICIT TAGS ::=
BEGIN

    IMPORTS OPERATION, ERROR FROM Remote-Operations-Information-Objects
        {joint-iso-ITU-T remote-operations(4) informationObjects(5) version1(0)notation (0)};

    IMPORTS hilNotificationOperations
    FROM SecurityDomainDefinitions { ccitt (0) identified-organization (4) etsi (0) securityDomain (2)}

    IMPORTS CallIdentifier, TimeStamp, LawfulInterceptionIdentifier
    FROM HI2Operations { ccitt (0) identified-organization (4) etsi (0) securityDomain (2)
    lawfulIntercept (2) hi2 (1) version1 (1)};

    Sending-of-HI1-Notification    OPERATION
                                ARGUMENT    HI1-Operation
                                RESULT
                                ERROR
                                CODE    globalValue { hilNotificationOperations version1 (1)}
-- Class 2 operation . The timer shall be set to a value between 3 s and 240 s. The timer default
value is 60s.
Note: The value for this timer is to be set on the equipment waiting for the returned message; its
value shall be agreed between the NWO/AP/SvP and the LEA, depending on their equipment properties.

HI1-Operation ::= CHOICE {

    liActivated      [1] Notification,
    liDeactivated    [2] Notification,
    liModified       [3] Notification,
    alarms-indicator [4] Alarm-Indicator
    }
Notification ::= SEQUENCE {
    lawfulInterceptionIdentifier [1] LawfulInterceptionIdentifier ,
--This identifier is the LIID identity provided with the warrant for each target .
    callIdentifier [2] CallIdentifier OPTIONAL,
--only the NWO/PA/SvPIdentifier is provided (the one provided with the Warrant)
    timeStamp [3] TimeStamp,
--date and time of the report.)
    ...}

Alarm-Indicator ::= SEQUENCE {
    callIdentifier [1] CallIdentifier OPTIONAL,
--only the NWO/PA/SvPIdentifier is provided (the one provided with the Warrant)
    timeStamp [2] TimeStamp,
--date and time of the report.
    alarm-information [3] OCTET STRING (SIZE (1 .. 25)),
--Provides information about alarms (free format)
    ...}

--PARAMETERS

END -- H1CircuitDataOperations

```

A.5 Intercept related information (HI2)

Table A.4: ASN1 description of IRI (HI2 interface)

HI2Operations { ccitt (0) identified-organization (4) etsi (0) securityDomain (2) lawfulIntercept (2) hi2 (1) version1 (1)}

DEFINITIONS IMPLICIT TAGS ::=

BEGIN

EXPORTS Sending-of-IRI, CallIdentifier, TimeStamp, OperationErrors, SMS-report,
LawfulInterceptionIdentifier, Supplementary-Services, CallIdentifier, CC-Link-Identifier;

IMPORTS OPERATION, ERROR FROM Remote-Operations-Information-Objects
{joint-iso-ITU-T remote-operations(4) informationObjects(5) version1(0)notation (0)}

IMPORTS hi2DomainId

FROM SecurityDomainDefinitions { ccitt (0) identified-organization (4) etsi (0) securityDomain (2)};

Sending-of-IRI OPERATION

ARGUMENT IRIContent

RESULT

ERROR OperationErrors

CODE globalValue { hi2DomainId sending-of-IRI (1) version1 (1)}

--- Class 2 operation . The timer shall be set to a value between 3 s and 240 s. The timer.default value is 60s.

NOTE: The same note as for HI management operation applies.

IRIContent

::= CHOICE {

iRI-Begin-record [1] IRI-Parameters,

--at least one optional parameter must be included within the iRI-Begin-Record

iRI-End-record [2] IRI-Parameters,

iRI-Continue-record [3] IRI-Parameters,

--at least one optional parameter must be included within the iRI-Continue-Record

iRI-Report-record [4] IRI-Parameters,

--at least one optional parameter must be included within the iRI-Report-Record

...}

OperationErrors

::= ENUMERATED {

unknown-version(0),

missing-parameter(1),

unknown-parameter-value(2),

unknown-parameter(3),

}

--This values may be sent by the LEMF, when an operation or a parameter is misunderstood,

IRI-Parameters

::= SEQUENCE {

lawfulInterceptionIdentifier [1] LawfulInterceptionIdentifier ,

--This identifier is associated to the target.

callIdentifier [2] CallIdentifier,

--used to uniquely identify an intercepted call.

cC-Link-Identifier [15] CC-Link-Identifier OPTIONAL,

--Depending on a network option, this parameter may be used to identify a CC link

--in case of multiparty calls.

timeStamp [3] TimeStamp,

--date and time of the event triggering the report.)

intercepted-Call-Direct [4] ENUMERATED {

not-Available(0),

originating-Target(1),

terminating-Target(2),

...} OPTIONAL,

intercepted-Call-State [5] Intercepted-Call-State OPTIONAL,

ringingDuration [6] OCTET STRING (SIZE (3)) OPTIONAL,

--Duration in seconds. BCD coded : HHMMSS

conversationDuration [7] OCTET STRING (SIZE (3)) OPTIONAL,

--Duration in seconds. BCD coded : HHMMSS

locationOfTheTarget [8] Location OPTIONAL,

--location of the target subscriber

partyInformation [9] SET SIZE (1..10) OF PartyInformation,

--This parameter provides the concerned party (Originating, Terminating

--or forwarded party), the identiy(ies) of the party and all the information

--provided by the party.

callContentLinkInformation [10] SEQUENCE {

cCLink1Characteristics [1] CallContentLinkCharacteristics OPTIONAL,

```

--information concerning the Content of Communication Link Tx channel established
-- toward the LEMF (or the sum signal channel, in case of mono mode).
cCLink2Characteristics      [2] CallContentLinkCharacteristics OPTIONAL,
--information concerning the Content of Communication Link Rx channel established
--toward the LEMF.
... } OPTIONAL,

release-Reason-Of-Intercepted-Call [11] OCTET STRING (SIZE (2)) OPTIONAL,
--Release cause coded in [31] format. This parameter indicates the reason why the
--intercepted call cannot be established or why the intercepted call has been released after
--the active phase.

nature-Of-The-intercepted-call [12] ENUMERATED {
--Nature of the intercepted „call„ :
  gSM-ISDN-PSTN-circuit-call(0),
--the possible UUS content is sent through the HI3 „data„ interface
--the possible call content call is established through the HI3 „circuit„ interface
  gSM-SMS-Message(1),
--the SMS content is sent through the HI2 or HI3 „data„ interface
  uUS4-Messages(2),
--the UUS content is sent through the HI3 „data„ interface
  tETRA-circuit-call(3),
--the possible call content call is established through the HI3 „circuit„ interface
--the possible data are sent through the HI3 „data„ interface
  teTRA-Packet-Data(4),
--the data are sent through the HI3 „data„ interface
  gPRS-Packet-Data(5),
--the data are sent through the HI3 „data„ interface
  ...}

serverCenterAddress      [13] PartyInformation OPTIONAL,
--e.g. in case of SMS message this parameter provides the address of the relevant
--server within
--the calling (if server is originating) or called (if server is terminating) party address
--parameters.

sms                      [14] SMS-report OPTIONAL,
--this parameter provides the SMS content and associated information

national-Parameters      [16] National-Parameters OPTIONAL,
...}

-- PARAMETERS FORMATS

CallIdentifier ::= SEQUENCE {
  call-Identity-Number      [0] OCTET STRING (SIZE (1 .. 8)) OPTIONAL,
  --Temporary Identifier of an intercepted call to uniquely identify an intercepted call
  --within the node (free format). This parameter is mandatory if there is associated
  --information sent over HI3interface (CCLink, data,..) or when CallIdentifier is used
  --for IRI other than „IRI-Report-record„

  network-Identifier [1] Network-Identifier,
  ...}
  --NB : The same „CallIdentifier„ value is sent :
  --with the HI3 information for correlation purpose between the IRI and the
  --information
  --sent on the HI3 interfaces (CCLink, data, ..)
  --with each IRI associated to a same intercepted call for correlation purpose between
  --the different IRI

Network-Identifier ::= SEQUENCE {
  operator-Identifier      [0] OCTET STRING (SIZE (1 .. 5)),
  --it's a notification of the NWO/AP/Svp in ASCII- characters
  --the parameter is mandatory.
  network-Element-Identifier [1] Network-Element-Identifier OPTIONAL,
  ...}

Network-Element-Identifier ::= CHOICE {
  e164-Format      [1] OCTET STRING (SIZE (1 .. 25)),
  --E164 address of the node in international format. Coded in the same format as the
  --calling party number parameter of the ISUP (parameter part : [5])
  x25-Format      [2] OCTET STRING (SIZE (1 .. 25)),
  --X25 address
  iP-             [3] OCTET STRING (SIZE (1 .. 25)),
  --IP address
  dns-Format      [4] OCTET STRING (SIZE (1 .. 25)),
  --DNS address
  ...}

CC-Link-Identifier ::= OCTET STRING (SIZE (1..8))
--Depending on a network option, this parameter may be used to identify a CCLink
--in case of multiparty calls.

```



```

TimeStamp ::= CHOICE {
    localTime          [0] LocalTimeStamp,
    utcTime            [1] UTCTime}
    --The UTC Time is an ASN1 universal class and its format is the one defined
    --in case b) of the ASN1 recommendation [33] (year month day
    --hour minutes seconds)

LocalTimeStamp ::= SEQUENCE {
    generalizedTime    [0] GeneralizedTime,
    --The generalized Time format is an ASN1 universal class and its format is the
    --one defined in case a) of the ASN1 recommendation [33], b) (year
    --month day hour minutes seconds)
    winterSummerIndication [1] ENUMERATED { notProvided(0), winterTime(1),
        summerTime(2), ... }}

PartyInformation ::= SEQUENCE {
    partyQualifier     [0] ENUMERATED {
        originating-Party(0),
        --In this case, the partyInformation parameter provides the identities related to
        --he originating party and all information provided by this party.
        --This parameter provides also all the information concerning the redirecting
        --party when a forwarded call reaches a target.
        terminating-Party(1),
        --In this case, the partyInformation parameter provides the identities related to
        --the terminating party and all information provided by this party.
        forwarded-to-Party(2),
        --In this case, the partyInformation parameter provides the identities related to
        --the forwarded to party and parties beyond this one and all information
        --provided by this parties, including the call forwarding reason .
        ...},
    partyIdentity      [1] SEQUENCE {
        imei            [1] OCTET STRING (SIZE (8)) OPTIONAL,
        --See MAP format [32]
        tei             [2] OCTET STRING (SIZE (1..15)) OPTIONAL,
        --ISDN-based Terminal Equipment Identity
        imsi            [3] OCTET STRING (SIZE (3..8)) OPTIONAL,
        --See MAP format [32] International Mobile
        --Station Identity E.212 number beginning with Mobile Country Code

        callingPartyNumber [4] CallingPartyNumber OPTIONAL ,
        --The calling party format is used to transmit the identity of a calling party
        calledPartyNumber [5] CalledPartyNumber OPTIONAL ,
        --The called party format is used to transmit the identity of a called party or
        --a forwarded to party.
        ...},

    services-Information [2] Services-Information OPTIONAL,
    --This parameter is used to transmit all the information concerning the
    --complementary information associated to the basic call

    supplementary-Services-Information [3] Supplementary-Services OPTIONAL,
    --This parameter is used to transmit all the information concerning the
    --activation/invocation of supplementary services during a call or out-of call not
    --provided by the previous parameters.
    ...}

CallingPartyNumber ::= CHOICE {
    iSUP-Format        [1] OCTET STRING (SIZE (1..25)),
    --Encoded in the same format as the calling party number (parameter field)
    --of the ISUP (see [5])
    dSS1-Format        [2] OCTET STRING (SIZE (1..25)),
    --Encoded in the format defined for the value part of the Calling party number
    --inf. ele. of DSS1 protocol [6]. The DSS1 Information
    --element identifier and the DSS1 length are not included .
    ...}

CalledPartyNumber ::= CHOICE {
    iSUP-Format        [1] OCTET STRING (SIZE (1..25)),
    --Encoded in the same format as the called party number (parameter field)
    --of the ISUP (see [5])
    mAP-Format         [2] OCTET STRING (SIZE (1..25)),
    --Encoded as AddressString of the MAP protocol [32]
    dSS1-Format        [3] OCTET STRING (SIZE (1..25)),
    --Encoded in the format defined for the value part of the Called party number inf.
    --ele. Of DSS1 protocol [6] . The DSS1 Information element
    --identifier and the DSS1 length are not included .
    ...}

Location ::= SEQUENCE {
    e164-Number        [1] OCTET STRING (SIZE (1 .. 25)) OPTIONAL,
    --coded in the same format as the ISUP location number (parameter
    --field) of the ISUP (see [5])
    globalCellID       [2] OCTET STRING (SIZE (5..7)) OPTIONAL,

```

```

--see MAP format (see [32])
tetraLocation      [3] TetraLocation OPTIONAL,
...}

```

```

TetraLocation ::= CHOICE {
ms-Loc             [1] SEQUENCE {
mcc                [1] INTEGER (0...1023),
--16 bits ETS [40]
mnc                [2] INTEGER (0...1023),
--14 bits ETS [40]
lai                [3] INTEGER (0...65535),
--14 bits ETS [40]
ci                 [4] INTEGER OPTIONAL
},
-- (to be completed)
ls-Loc             [2] INTEGER
-- (to be confirmed and completed)
}

```

```

CallContentLinkCharacteristics ::= SEQUENCE {
cCLink-State       [1] CCLink-State OPTIONAL,
--current state of the CCLink
release-Time        [2] TimeStamp OPTIONAL,
--date and time of the release of the Call Content Link.
release-Reason      [3] OCTET STRING (SIZE(2)) OPTIONAL,
--Release cause coded in [31] format.
LEMF-Address        [4] CalledPartyNumber OPTIONAL,
--Directory number used to route the call toward the LEMF.
...}

```

```

CCLink-State ::= ENUMERATED {
setUPInProgress(1),
callActive(2),
callReleased(3),
lack-of-resource(4),
--the lack-of-resource state is sent when a CC Link cannot
--be established because of lack of resource at the MF level
...}

```

```

Intercepted-Call-State ::= ENUMERATED {
idle(1),
--When the intercept call is released, the state is IDLE and the reason is provided
--by the release-Reason-Of-Intercepted-Call parameter.
setUpInProgress(2),
--The setup of the call is in process
connected(3),
--The answer has been received
...}

```

```

Services-Information ::= SEQUENCE {
iSUP-parameters    [1] ISUP-parameters,
dSS1-parameters-codeset-0 [2] DSS1-parameters-codeset-0 OPTIONAL,
...}

```

```

ISUP-parameters ::= SET SIZE (1..256) OF OCTET STRING (SIZE (1..256))
--each «OCTET STRING» contains one additional ISUP parameter TLV coded not already defined in
--the previous parameters. The Tag value is the one given in Recommendation [5] .
--The Length and the Value are coded in accordance with the parameter definition in recommendation
--[5]. Hereafter are listed the main parameters. However other parameters may be added :

```

```

--Transmission medium requirement : format defined in recommendation [5]
--This parameter can be provided with the «Party Information» of the „calling party„

--Transmission medium requirement prime : format defined in recommendation [5]
--This parameter can be provided with the «Party Information» of the „calling party„

```

```

DSS1-parameters-codeset-0 ::= SET SIZE (1..256) OF OCTET STRING (SIZE (1..256))
--each «OCTET STRING» contains one DSS1 parameter of the codeset 0. The parameter is coded as
--described in recommendation [6] (The DSS1 Information element identifier and the DSS1 length
--are included). Hereafter are listed the main parameters (However other parameters may be added) :

```

```

--Bearer capability : this parameter may be repeated. Format defined in recommendation [6]
--This parameter can be provided with the «Party Information» of the «calling party»,
--«called party» or «forwarded to party».

```

```

--High Layer Compatibility : this parameter may be repeated. Format defined in
-- recommendation [6].
--This parameter can be provided with the «Party Information» of the «calling party»,
--«called party» or « forwarded to party».

```

```

--Low Layer capability : this parameter may be repeated. Format defined in
-- recommendation [6].
--This parameter can be provided with the «Party Information» of the «calling party»,

```

--«called party» or «forwarded to party».

```
Supplementary-Services ::= SEQUENCE {
  standard-Supplementary-Services [1] Standard-Supplementary-Services OPTIONAL ,
  non-Standard-Supplementary-Services [2] Non-Standard-Supplementary-Services OPTIONAL,
  other-Services [3] Other-Services OPTIONAL,
  ...}
```

```
Standard-Supplementary-Services ::= SEQUENCE {
  iSUP-SS-parameters [1] ISUP-SS-parameters,
  dSS1-SS-parameters-codeset-0 [2] DSS1-SS-parameters-codeset-0 OPTIONAL,
  dSS1-SS-parameters-codeset-4 [3] DSS1-SS-parameters-codeset-4 OPTIONAL,
  dSS1-SS-parameters-codeset-5 [4] DSS1-SS-parameters-codeset-5 OPTIONAL,
  dSS1-SS-parameters-codeset-6 [5] DSS1-SS-parameters-codeset-6 OPTIONAL,
  dSS1-SS-parameters-codeset-7 [6] DSS1-SS-parameters-codeset-7 OPTIONAL,
  dSS1-SS-Invoke-components [7] DSS1-SS-Invoke-Components OPTIONAL,
  mAP-SS-Parameters [8] MAP-SS-Parameters OPTIONAL,
  mAP-SS-Invoke-Components [9] MAP-SS-Invoke-Components OPTIONAL,
  ...}
```

```
Non-Standard-Supplementary-Services ::= SET SIZE (1..20) OF CHOICE {
  simpleIndication [1] SimpleIndication,
  sciData [2] SciDataMode,
  ...}
```

```
Other-Services ::= SET SIZE (1..50) OF OCTET STRING (SIZE (1..256))
  --reference manufacturer manuals
```

```
ISUP-SS-parameters ::= SET SIZE (1..256) OF OCTET STRING (SIZE (1..256))
--each «OCTET STRING» contains one additional ISUP parameter TLV coded not already defined in
--the previous parameters. The Tag value is the one given in recommendation [5] .
--The Length and the Value are coded in accordance with the parameter definition in recommendation
-- [5]. Hereafter are listed the main parameters. However other parameters may be added :
```

```
--Connected Number : format defined in recommendation [5]
--This parameter can be provided with the « Party Information» of the
--«called party» or «forwarded to party»
```

```
--RedirectingNumber : format defined in recommendation [5]
--This parameter can be provided with the « Party Information» of the «originating party»
```

```
--Original Called Party Number : format defined in recommendation [5]
--This parameter can be provided with the « Party Information» of the
--«originating party»..
```

```
--Redirection information : format defined in recommendation [5]
--This parameter can be provided with the «Party Information» of the
--«originating party» , «forwarded to party» or/and «Terminating party»
```

```
--Redirection Number : format defined in recommendation [5]
--This parameter can be provided with the «Party Information» of the
--«forwarded to party» or «Terminating party»
```

```
--Call diversion information: format defined in recommendation [5]
--This parameter can be provided with the «Party Information» of the
--«forwarded to party» or «Terminating party» .
```

```
--Generic Number : format defined in recommendation [5]
--This parameter can be provided with the «Party Information»of the
--«calling party», «called party» or «forwarded to party».
--This parameters are used to transmit additional identities (additional ,calling party
--number, additional called number, ...)
```

```
--Generic Notification : format defined in recommendation [5]
--This parameter may be provided with the «Party Information» of the
--«calling party», «called party» or «forwarded to party».
--This parameters transmit the notification to the other part of the call of the supplementary
--services activated or invoked by a subscriber during the call.
```

```
--CUG Interlock Code : format defined in recommendation [5]
--This parameter can be provided with the «Party Information» of the
--«calling party».
```

```
DSS1-SS-parameters-codeset-0 ::= SET SIZE (1..256) OF OCTET STRING (SIZE (1..256))
--each «OCTET STRING» contains one DSS1 parameter of the codeset 0. The parameter is coded as
--described in recommendation [6] (The DSS1 Information element identifier and the DSS1 length
--are included). Hereafter are listed the main parameters (However other parameters may be added) :
```

```
--Calling Party Subaddress : Format defined in recommendation [6].
--This parameter can be provided with the «Party Information» of the
--«calling party».
```

```
--Called Party Subaddress : Format defined in recommendation [6].
```

--This parameter can be provided with the «Party Information» of the
--«calling party», .

--Connected Subaddress. : Format defined in recommendation (see [14]).
--This parameter can be provided with the «Party Information» of the
--«called party» or «forwarded to party».

--Connected Number : Format defined in recommendation (see [14]).
--This parameter can be provided with the «Party Information» of the
--«called party» or «forwarded to party».

--Keypad facility : Format defined in recommendation [6].
--This parameter can be provided with the «Party Information» of the
--«calling party», «called party» or «forwarded to party».

DSS1-SS-parameters-codeset-4 ::= SET SIZE (1..256) OF OCTET STRING (SIZE (1..256))
--each «OCTET STRING» contains one DSS1 parameter of the codeset 4. The parameter is coded as
--described in the relevant recommendation .

DSS1-SS-parameters-codeset-5 ::= SET SIZE (1..256) OF OCTET STRING (SIZE (1..256))
--each «OCTET STRING» contains one DSS1 parameter of the codeset 5. The parameter is coded as
--described in the relevant national recommendation .

DSS1-SS-parameters-codeset-6 ::= SET SIZE (1..256) OF OCTET STRING (SIZE (1..256))
--each «OCTET STRING» contains one DSS1 parameter of the codeset 6. The parameter is coded as
--described in the relevant local network recommendation .

DSS1-SS-parameters-codeset-7 ::= SET SIZE (1..256) OF OCTET STRING (SIZE (1..256))
--each «octet string» contains one DSS1 parameter of the codeset 7. The parameter is coded as
--described in the relevant user specific recommendation .

DSS1-SS-Invoke-Components ::= SET SIZE (1..256) OF OCTET STRING (SIZE (1..256))
--each «octet string» contains one DSS1 Invoke or Return Result component.
--The invoke or return result component is coded as
--described in the relevant DSS1 supplementary service recommendation.
--Invoke or Return Result component (BeginCONF) : reference [19]
--Invoke or Return Result component (AddCONF) : reference [19]
--Invoke or Return Result component (SplitCONF) : reference [19]
--Invoke or Return Result component (DropCONF) : reference [19]
--Invoke or Return Result component (IsolateCONF) : reference [19]
--Invoke or Return Result component (ReattachCONF) : reference [19]
--Invoke or Return Result component (PartyDISC) : reference [19]
--Invoke or Return Result component (MCIDRequest) : reference [16]
--Invoke or Return Result component (Begin3PTY) : reference [20]
--Invoke or Return Result component (End3PTY) : reference [20]
--Invoke or Return Result component (ECTExecute) : reference [25]
--Invoke or Return Result component (ECTInform) : reference [25]
--Invoke or Return Result component (ECTLinkIdRequest) : reference [25]
--Invoke or Return Result component (ECTLoopTest) : reference [25]
--Invoke or Return Result component (ExplicitECTExecute) : reference [25]
--Invoke or Return Result component (ECT : RequestSubaddress) : reference [25]
--Invoke or Return Result component (ECT : SubaddressTransfer) : reference [25]
--Invoke or Return Result component (CF : ActivationDiversion) : reference [21]
--Invoke or Return Result component (CF : DeactivationDiversion) : reference [21]
--Invoke or Return Result component (CF : ActivationStatusNotification) : reference [21]
--Invoke or Return Result component (CF : DeactivationStatusNotification) : reference [21]
--Invoke or Return Result component (CF : InterrogationDiversion) : reference [21]
--Invoke or Return Result component (CF : InterrogationServedUserNumber) : reference [21]
--Invoke or Return Result component (CF : DiversionInformation) : reference [21]
--Invoke or Return Result component (CF : CallDeflection) : reference [21]
--Invoke or Return Result component (CF : CallRerouting) : reference [21]
--Invoke or Return Result component (CF : DivertingLegInformation1) : reference [21]
--Invoke or Return Result component (CF : DivertingLegInformation2) : reference [21]
--Invoke or Return Result component (CF : DivertingLegInformation3) : reference [21]
--other invoke or return result components ...

MAP-SS-Invoke-Components ::= SET SIZE (1..256) OF OCTET STRING (SIZE (1..256))
--each «octet string» contains one MAP Invoke or Return Result component.
--The invoke or return result component is coded as
--described in the relevant MAP supplementary service recommendation.

MAP-SS-Parameters ::= SET SIZE (1..256) OF OCTET STRING (SIZE (1..256))
--each «octet string» contains one MAP Parameter. The parameter is coded as
--described in the relevant MAP supplementary service recommendation.

SimpleIndication ::= ENUMERATED {
call-Waiting-Indication(0),
--the target has received a call waiting indication for this call
add-conf-Indication(1),
--this call has been added to a conference
call-on-hold-Indication(2),
--indication that this call is on hold
retrieve-Indication(3),

```

--indication that this call has been retrieved
    suspendIndication(4),
-- indication that this call has been suspended
    resume-Indication(5),
-- indication that this call has been resumed
    answer-Indication(6),
--indication that this call has been answered
    ... }

```

```

SciDataMode ::= OCTET STRING (SIZE (1..256))

```

```

SMS-report ::= SEQUENCE {
    callIdentifier [1] CallIdentifier,
    -- used to uniquely identify an intercepted call : the same used for the
    -- relevant IRI
    timeStamp [2] TimeStamp,
    --date and time of the report. The format is
    --the one defined in case a) of the ASN1 recommendation [33].
    --(year month day hour minutes seconds)
    sms-Contents [3] SEQUENCE {
        initiator [1] ENUMERATED {
            --party which sent the SMS
            target(0),
            server(1),
            undefined-party(2),
            ... },
        transfer-status [2] ENUMERATED {
            --the transfer of the SMS message succeeds
            succeed-transfer(0),
            not-succeed-transfer(1),
            undefined(2),
            ... } OPTIONAL,
        other-message [3] ENUMERATED {
            --in case of terminating call, indicates if the server will send
            --other SMS
            yes(0),
            no(1),
            undefined(2),
            ... } OPTIONAL,
        content [4] OCTET STRING (SIZE (1 .. 270)) ,
        --Encoded in the format defined for the SMS mobile
        ... }}

```

```

LawfulInterceptionIdentifier ::= OCTET STRING (SIZE (1..25))

```

```

National-Parameters ::= SET SIZE (1..40) OF OCTET STRING (SIZE (1..256))

```

```

--Content defined by national law

```

```

END -- OF HI2Operations

```

A.6 User data packet transfer (HI3 interface)

Table A.5: ASN.1 description of circuit_data transfer operation (HI3 interface)

HI3CircuitDataOperations { ccitt (0) identified-organization (4) etsi (0) securityDomain (2) lawfulIntercept (2) hi3 (2) circuitLI (1) version1 (1)}

```

DEFINITIONS IMPLICIT TAGS ::=

```

```

--The following operations are used to transmit user data which can be exchanged via the DSS1, ISUP
or
--MAP signalling (e.g. UUS, SMS)
BEGIN

```

```

    IMPORTS OPERATION, ERROR FROM Remote-Operations-Information-Objects
        {joint-iso-ITU-T remote-operations(4) informationObjects(5) version1(0)notation (0)}

```

```

    IMPORTS hi3CircuitLISubDomainId
    FROM SecurityDomainDefinitions { ccitt (0) identified-organization (4) etsi (0) securityDomain (2)}

```

```

    IMPORTS CallIdentifier, TimeStamp, OperationErrors, Supplementary-Services, SMS-report
    FROM HI2Operations HI2Operations { ccitt (0) identified-organization (4) etsi (0)
    securityDomain (2)
    lawfulIntercept (2) hi2 (1) version1 (1)} ;

```

```

    Circuit-Call-related-Services OPERATION
        ARGUMENT Content-Report
        RESULT
        ERROR OperationErrors

```

```

CODE globalValue { hi3CircuitLISubDomainId circuit-Call-Serv (1) version1 (1)}
--- Class 2 operation . The timer shall be set to a value between 3 s and 240 s. The timer default
value is 60s.
--NOTE: The same note as for HI management operation applies.

No-Circuit-Call-related-Services OPERATION
ARGUMENT Content-Report
RESULT
ERROR OperationErrors
 ::= globalValue { hi3CircuitLISubDomainId no-Circuit-Call-Serv (2) version1 (1)}
--Class 2 operation . The timer must be set to a value between 10s and 120s. The timer default value
is 60s.

Content-Report ::= SEQUENCE {
callIdentifier [1] CallIdentifier,
--used to uniquely identify an intercepted call: the same as used for the relevant IRI
timeStamp [2] TimeStamp,

initiator [3] ENUMERATED {
originating-party(0),
terminating-party(1),
forwarded-to-party(2),
undefined-party(3),
... }OPTIONAL,
content [4] Supplementary-Services OPTIONAL,

--UII are encoded in the format defined for the User-to-user information parameter
--of the ISUP protocol (see [5]).Only one UII parameter is sent per message.
sms-report [5] SMS-report OPTIONAL,
... }

END -- HI3CircuitDataOperations

```

A.7 TETRA data transfer (HI3 interface)

Table A.6: ASN.1 description of TETRA data transfer operation (HI3 interface)

HI3TETRADataOperations { ccitt (0) identified-organization (4) etsi (0) securityDomain (2) lawfulIntercept (2) hi3 (2) tETRALI (2) version1 (1)}

The definition of this interface is for further study.
DEFINITIONS IMPLICIT TAGS ::=

```

BEGIN

EXPORTS;
IMPORTS OPERATION, ERROR FROM Remote-Operations-Information-Objects
{joint-iso-ITU-T remote-operations(4) informationObjects(5) version1(0)notation (0)};
CallIdentifier
FROM HI2Operations {hi2DomainId version1 (1)} ;

Sending-of-TETRA-Data OPERATION
ARGUMENT xxxyyy
RESULT
ERROR
CODE globalValue { hi3TETRALISubDomainId sending-of-XXX (x) version1 (1)}

END -- HI3TETRADataOperations

```

A.8 GPRS data transfer (HI3 interface)

Table A.7: ASN.1 description of GPRS data transfer operation (HI3 interface)

HI3GPRSDataOperations { ccitt (0) identified-organization (4) etsi (0) securityDomain (2) lawfulIntercept (2) hi3 (2) gPRSLI (3) version1 (1)}

The definition of this interface is for further study.

DEFINITIONS IMPLICIT TAGS ::=
BEGIN

```

IMPORTS OPERATION, ERROR FROM Remote-Operations-Information-Objects

```

```

    {joint-iso-ITU-T remote-operations(4) informationObjects(5) version1(0)notation (0)};
CallIdentifier
    FROM HI2Operations {hi2DomainId version1 (1)} ;

Sending-of-GPRS-Data    OPERATION
                        ARGUMENT    xxxyyy
                        RESULT
                        ERROR
    CODE    globalValue { hi3GPRSLISubDomainId sending-of-XXX (1) version1 (1)}
END -- HI3GPRSDDataOperations

```

A.9 Definition of the UUS1 content associated to the CC link

Table A.8: ASN.1 description of the UUS1 content associated to the CC link

HI3CCLinkData { ccitt (0) identified-organization (4) etsi (0) securityDomain (2) lawfulIntercept (2) hi3 (2) cclinkLI (4) version1 (1)}

```

DEFINITIONS IMPLICIT TAGS ::=
BEGIN

    IMPORTS
        LawfulInterceptionIdentifier, CallIdentifier, CC-Link-Identifier
            FROM HI2Operations HI2Operations { ccitt (0) identified-organization (4) etsi (0)
securityDomain (2)
lawfulIntercept (2) hi2 (1) version1 (1)} ;

UUS1_Content ::= SEQUENCE {
    lawfulInterceptionIdentifier [1] LawfullInterceptionIdentifier,
    callIdentifier [2] CallIdentifier,
    cC-Link-Identifier [3] CC-Link-Identifier OPTIONAL,
    direction_Indication [4] Direction_Indication,
    bearer_capability [5] OCTET STRING (1..12) OPTIONAL,
    -- transport the Bearer capability information element (value part)
    -- Protocol: ETS [6]
    ...}
    Direction_Indication ::= ENUMERATED {
        mono_mode(0),
        cc_from_target(1),
        cc_from_other_party(2),
        ...}
END -- HI3CCLinkData

```

Annex B (normative): Detailed procedures for supplementary services (circuit switched)

B.1 Advice of Charge Services (AOC)

No impact.

Advice of charge information is not included in IRI records.

B.2 Call Waiting

B.2.1 Call Waiting at target: CC links

In case of option A "CC links for all calls", a CC link is set up for the waiting call, using the standard procedures for terminating calls. In case of option B "CC links for active calls", no CC link is set up for the waiting call, it is treated like a held call.

With respect to CC links, the same configurations as for Call Hold apply.

Procedure, when the target accepts the waiting call: See retrieve of a held call (clause B.3).

B.2.2 Call Waiting: IRI records

B.2.2.1 Target is served user

If Call Waiting is invoked at the target access by another (calling) party: The IRI-BEGIN record or a following IRI-CONTINUE record for the waiting call shall contain the LI specific parameter *call waiting indication*.

B.2.2.2 Other party is served user

If Call Waiting is invoked at the other (called) party's access: If a *CW notification* is received by the target's switching node, it shall be included in an IRI-CONTINUE record; it may be a separate record, or the next record of the basic call sequence.

B.3 Call Hold/Retrieve

B.3.1 CC links for active and non-active calls (option A)

If an active call is put on hold, its CC links shall stay intact; as an option, the signal from the held party is not switched through to the LEMF.

If the target sets up a new call, while one call is on hold, this call is treated like a normal originating call, i.e. a new LI configuration (CC links, IRI records) is established.

B.3.2 Reuse of CC links for active calls (option B)

If an active call is put on hold, its CC links shall not immediately be disconnected; as an option, the signal from the held party is not switched through to the LEMF.

If the target sets up a new call, or retrieves a previously held call, while one target call, which still owns CC links, is on hold, these CC links shall be used for the signals of the new active call.

B.3.3 IRI records

B.3.3.1 Invocation of Call Hold or Retrieve by target:

An IRI-CONTINUE record with the LI specific parameter hold indication or retrieve indication, respectively, shall be sent.

B.3.3.2 Invocation of Hold or Retrieve by other parties:

An IRI-CONTINUE record with a call hold or retrieve notification shall be sent within an IRI-CONTINUE record, if it has been received by the signalling protocol entity of the target call.

B.4 Explicit Call Transfer

B.4.1 Explicit Call Transfer, CC link

During the preparation phase of a transfer, the procedures for Call Hold / Retrieve are applicable.

If the served (transferring) user is the target, its original call is released. This terminates also the CC link, and causes an IRI-END record to be sent.

After transfer, two options exist:

- a) For the transferred call, CC links (and IRI records) shall be generated, in principle like for a forwarded call (similar to procedures in subclause B.16.1, case b)).
- b) The transferred call shall not be intercepted.

B.4.2 Explicit Call Transfer, IRI records

In addition to the basic or hold / retrieve / waiting call related records and parameters, during the reconfiguration of the call, ECT-specific information at the target's access is sent to the LEMF within IRI-CONTINUE records.

When the target leaves the call after transfer, an IRI-END record is sent, and the LI transaction is terminated. Options for the new call, after transfer: see section above.

B.5 Calling Line Identification Presentation (IRI Records)

B.5.1 Call originated by target (target is served user)

The standard CLI parameter of an originating target is not included as a supplementary service parameter in the IRI records.

If the target uses the two calling party number information elements delivery option (network option of the CLIP service) to provide a user provided, not screened number, this number is included in the IRI-BEGIN record (*originating-Party* information), as a generic number parameter. The network provided default number of the access is, as without this option, not included in an IRI record.

B.5.2 Call terminated at target (other party is served user)

The CLI sent from the other party is included in the IRI-BEGIN record (*originating-Party* information), irrespective of a restriction indication. An eventually received second number (case two number delivery option) is included in the IRI record as supplementary services information (Generic Number parameter).

B.6 Calling Line Identification Restriction (CLIR)

For use by LI, the restriction is ignored, but copied within the CLI parameter to the IRI record.

B.7 Connected Line Identification Presentation (COLP)

B.7.1 Call terminated at target (target is served user)

A *connected number parameter* received from the target shall be included in an IRI record (*terminating-Party* information), if it is not equal to the target identity.

B.7.2 Call originated by target (other party is served user)

If available, a *connected number parameter* as received from the other (terminating) party shall be included in an IRI record (*terminating-Party* information).

B.8 Connected Line Identification restriction (COLR)

For use by LI, the restriction is ignored, but copied within the COL parameter to the IRI record.

B.9 Closed User Group (CUG)

In case of a CUG call, the closed user group interlock code shall be included in an IRI.

B.10 Completion of Call to Busy Subscriber (CCBS)

No impact.

The first call, which meets a (terminating) busy subscriber, and is released subsequently, is treated like a standard busy call, with no CCBS related IRI information.

The procedures for CCBS, until starting a new call attempt from the served user to the terminating user, including the CCBS recall, are not subject of LI.

B.11 Conference Call, Add-On (CONF)

B.11.1 Conference Calls, Add On: CC links

The CC links carry the same bit stream as sent to / received from the target, that is, the R_x call contains the sum signal of the conference, the T_x call contains the signal from the target.

The general rules for multi party calls (subclause 10.4) apply also for the various possible states during a conference (isolate, split, ...). The call to the conference device as such is treated like a standard call. In case of a n-party conference, there exist n+1 CC links in case of option "CC link for all calls", or just one CC link, in case of option "CC link for active calls".

B.11.2 Conference Calls: IRI records

In addition to the basic or hold / retrieve / waiting call related records and parameters, during the set up and eventual reconfigurations of a conference, CONF -specific information is sent to the LEMF within IRI records; for details see Annex E.

B.12 Three Party Service (Conference)

B.12.1 CC links

- a) Target is conference controller:

The 3PTY conference originates from a configuration with two single calls (one active, one held). When joining the calls to a conference, the CC links, which have carried the signals of the active target call are used to transmit the conference signals; that is, the R_x call contains the sum signal of the conference, the T_x call contains the signal from the target.

The second CC link set, for the previously held call stays intact. If the conference is released, and the initial state (1 held, 1 active call) is re-established, the required CC links are still available.

- b) Target is passive party of conference:

No impact on CC links.

B.12.2 Three Party Service, IRI Records

For the events indicating the start and the end of the 3PTY conference, IRI records are generated.

B.13 Meet-Me Conference (MMC)

No impact; calls to a MMC are treated as standard calls; the MMC device is not required to be subject of LI.

B.14 Direct Dialing In (DDI)

LI may be applied to a PABX access DN or to a DDI extension number according to national laws and requirements.

B.15 Multiple Subscriber Number (MSN)

LI shall be activated individually per MSN.

If LI has to be activated for a whole ISDN BA, activation commands shall be input by the LI administrator for each number; administrative procedure shall ensure, that all numbers are covered. If during a surveillance a MSN is added or removed, a LI administrative message shall be generated, see subclause 12.3.

B.16 Diversion Services (DIV)

Calls to a target, with a called party number equal to the intercepted target DN(s), but forwarded, are intercepted, i.e. CC links are set up, and IRI records are sent to the LEA. This applies for all kinds of call forwarding.

For calls forwarded by the other party (calling or called), the available diversion-related information is sent to the LEA.

B.16.1 Call Diversion by Target

B.16.1.1 Call Diversion by Target, CC links

In order to handle call diversion services by applying, as far as possible, common procedures, the following two cases are differentiated:

- a) Call Forwarding Unconditional (CFU), Call Forwarding Busy (NDUB):

In these cases, forwarding is determined, before seizing the target access. CC links are set up, immediately, for the forwarded call.

Other variants of Call Forwarding with immediate forwarding, i.e. without first seizing the target access, are handled in the same way (e.g. unconditional Selective Call Forwarding).

- b) Call Forwarding No Reply, Call Forwarding Busy (UDUB), Call Deflection, Partial Rerouting:

Initially, the target call is set up, and the call is intercepted like a basic call.

When forwarding takes place (e.g. after expiry of the CFNR timer), the original call is released; this causes also a release of the CC links and an IRI-END record to be sent. For the forwarded call, a new set up procedure, including a new LI transaction, takes place, causing new CC links and sending of IRI records (starting with a IRI-BEGIN record) to the LEA. This second phase corresponds to case a).

Other variants of Call Forwarding with forwarding after first seizing the target access, are handled in the same way.

In case of multiple forwarding, one call may be intercepted several times, if several parties are targets. Considering the maximum number of diversions for one call of 5 (ITU recommended limit), one call can be intercepted 7 times, from the same or different LEAs. In principle, these procedures are independent of each other.

B.16.1.2 Call Diversion by Target, IRI records

See subclause 8.4.3, case 2, related to the target's information, and case 3, related to the forwarded-to-party information.

As above for the CC links, the diversion types a) and b) are differentiated: For case a) diversions, the IRI is part of one transaction, IRI-BEGIN, -CONTINUE, -END, for case b) diversions, a first transaction informs about the call section, until diversion is invoked (corresponding to a basic, prematurely released call), a second transaction informs about the call section, when diversion is invoked (corresponding to case a).

B.16.2 Forwarded Call Terminated at Target

The CC link is handled in the standard way. The IRI-BEGIN record contains the available call diversion information, see subclause 8.4.3, case 1.

B.16.3 Call from Target Forwarded

The CC link is handled in the standard way. The IRI-BEGIN and possibly IRI-CONTINUE records contain the available call diversion related information, see subclause 8.4.3, case 3.

B.17 Variants of call diversion services

Variants of the above "standard" diversion services are treated in the same way as the corresponding "standard" diversion service.

B.18 Freephone (FPH)

No impact.

Freephone destinations with LI activated shall be intercepted at their final physical destination, interception at the translation point is at present not specified.

B.19 Malicious Call Identification (MCID)

CC links: No impact.

IRI records: If a terminating target or other party invokes MCID, the MCID response indicator parameter shall be included in a dedicated or the next regular IRI record.

B.20 Subaddressing (SUB)

The different types of subaddress information elements are part of the IRI records, in all basic and supplementary services cases, where they are present.

B.21 Terminal Portability (TP)

B.21.1 CC links

No impact.

B.21.2 IRI records

B.21.2.1 Invocation of Terminal Portability by target

Sending of the LI parameters suspend indication or resume indication in an IRI-CONTINUE record.

B.21.2.2 Invocation of Terminal Portability by other parties

Sending of the generic notification indicator, values user suspended or user resumed in an IRI-CONTINUE record.

B.22 User-to-User Signalling (UUS)

User-to-User parameters of services UUS1, UUS2 and UUS3 shall be reported as HI3, see clause 9.

If User-User information is not delivered from a target to the other party (e.g. due to overload in the SS No.7 network), no notification is sent to the LEA.

B.23 Abbreviated Address (AA)

No impact. The service access code and abbreviated number (user input) is not included in IRI records.

B.24 Fixed Destination Call (FDC)

No impact. The service access code (if applicable) is not included in IRI records.

B.25 Alarm Call (AC) / Wake Up Service (WUS)

No impact. A Wake Up call is intercepted in the standard way; the identity of the originating party may be missing.

B.26 Incoming Call Barring (ICB)

No impact.

a) Case terminating call to a target with ICB active:

In general, the barring condition of a target is detected before the target access is determined, consequently, an IRI -REPORT records is generated.

If the access would be determined, a standard IRI-END record is generated, with the applicable cause value.

b) Case target calls a party with ICB active:

In general, an IRI-BEGIN record has been sent already, and CC links have been set up. Consequently, a standard IRI-END record is generated, with the applicable cause value.

B.27 Outgoing Call Barring (OCB)

No impact.

For a barred call, a standard record may be generated; its type and content are depending on the point in the call, where the call was released due to OCB restrictions.

B.28 Completion of Calls on No Reply (CCNR)

No impact. See remarks to service CCBS.

B.29 Reverse Charging

No impact.

B.30 Line Hunting

All accesses of the group shall get the interception profile, independently of each other, if the whole group has to be intercepted (responsibility of the LI operator).

B.31 Message Wait Indication (MWI)

No impact. The information, that a message is waiting, is not sent to the LEA.

B.32 Name display

No impact. Name strings are not included in IRI records.

B.33 Tones, Announcements

No impact.

If the normal procedures, depending on the call state, result in sending the tone or announcement signal on the R_x CC link channel, this shall be transmitted as CC.

Annex C (normative): Application Service Element for the Handover Interface (ASE_HI)

C.1 Architecture

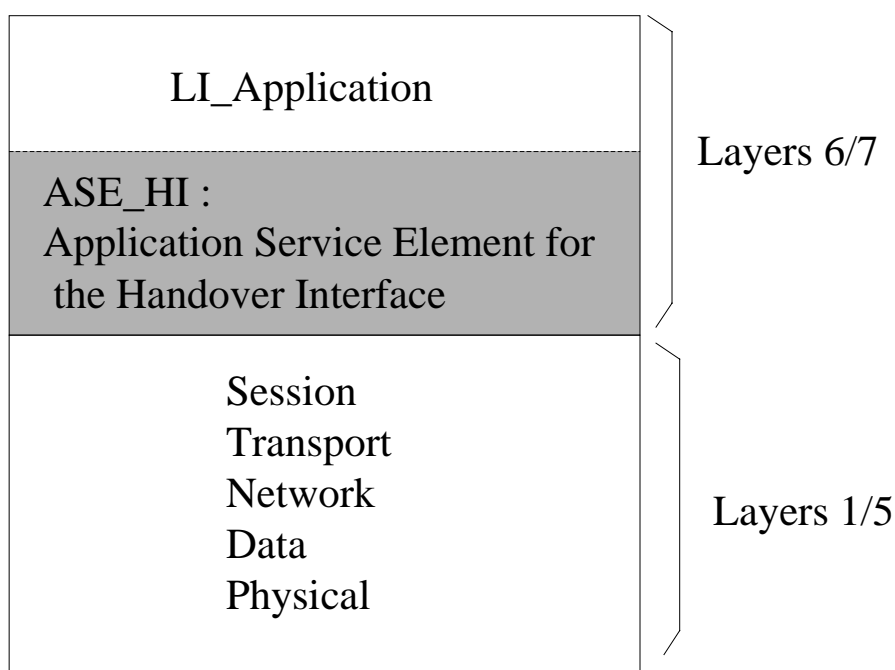

Figure C.1: Architecture

The ASE_HI manages the data link, the coding/decoding of the ROSE operations and the sending/receiving of the ROSE operations.

C.2 ASE_HI procedures

C.2.1 Sending part

To request the sending of data to a peer entity, the LI_Application provides the ASE_HI, the address of the peer entity, the nature of the data and the data.

On receiving a request of the LI_Application:

- If the data link toward the peer entity address is active, the ASE_HI, from the nature of the data provided, encapsulates this data in the relevant RO-Invoke operation.
- If the data link toward the peer entity address isn't active, the ASE_HI establishes this data link (see subclause C.2.3). Then, depending on the nature of the data provided, the ASE_HI encapsulates this data in the relevant RO-Invoke operation.

Depending on the natures of the data provided by the LI_Application, the ASE_HI encapsulates this data within the relevant ROSE operation:

- LI management notification: in this case the data provided by the application are encoded within the class 2 RO-Invoke operation "Sending_of_HI1_Notification". The ASN1 format is described in Annex A, Tables 1 and 3 (HI1 interface).
- IRI: in this case the data provided by the application are encoded within the class 2 RO-Invoke operation *Sending_of_IRI*. The ASN1 format is described in Annex A, Tables 1 and 4 (HI2 interface).
- SMS: in this case the data provided by the application are encoded within the class 2 RO-Invoke operation *Sending_of_IRI*. The ASN1 format is described in Annex A, Tables 1 and 4 (HI2 interface).
- User packet data transfer (used for data which can be exchanged via ISUP/DSS1/MAP signalling: e.g. UUS): in this case the data provided by the application are encoded:
 - either within the class 2 RO-Invoke operation "Circuit-Call-related-services" in case of data associated to a circuit call (for e.g. UUS 1 to 3) The ASN1 format is described in Annex A, Tables 1 and 5 (HI3 interface);
 - either within the class 2 RO-Invoke operation "No-Circuit-Call-related-services" in case of data not associated with a circuit call (for e.g. UUS 4.) The ASN1 format is described in Annex A, Tables 1 and 5 (HI3 interface).
- TETRA data transfer: in this case all the information provided by the application are encoded within the class 2 RO-Invoke operation "Sending_of_TETRA_Data". The ASN1 format is described in Annex A, Tables 1 and 6.
- GPRS data transfer: in this case all the information provided by the application are encoded within the class 2 RO-Invoke operation "Sending_of_GPRS_Data". The ASN1 format is described in Annex A, Tables 1 and 7.

Depending on the class of the operation, the ASE_HI may have to wait for an answer. In this case a timer, depending on the operation, is started on the sending of the operation and stopped on the receipt of an answer (RO_Result, RO_Error, RO_Reject).

On timeout of the timer, the ASE_HI indicates to the LI_Application that no answer has been received. It is under the LI_Application responsibility to send again the data or to inform the administrator of the problem.

On receipt of an answer component (after verification that the component isn't erroneous), the ASE_HI stop the relevant timer and acts depending on the type of component:

- On receipt of a RO_Result, the ASE_HI provide the relevant LI_Application an indication that the data has been received by the peer LI-application and the possible parameters contained in the RO_Result.
- On receipt of a RO_Error, the ASE_HI provide the relevant LI_Application an indication that the data hasn't been received by the peer LI-application and the possible "Error cause". The error causes are defined for each operation in the relevant ASN1 script. It is under the LI_Application responsibility to generate or not an alarm message toward an operator or administrator.
- On receipt of a RO_Reject_U/P, the ASE_HI provide the relevant LI_Application an indication that the data hasn't been received by the peer LI-application and the "Problem cause". The "problem causes" are defined in [35] to [37]. It is under the LI_Application responsibility to send again the data or to inform the operator/administrator of the error.

On receipt of an erroneous component, the ASE_HI acts as described in ITU-T Recommendations [35] to [37].

C.2.2 Receiving part

On receipt of a ROSE operation from the lower layers:

- When receiving operations from the peer entity, the ASE_HI verifies the syntax of the component and transmits the parameters to the LI-Application. If no error/problem is detected, in accordance with the [35] to [37] standard result (only Class2 operation are defined), the ASE_HI sends back a RO_Result which coding is determined by the relevant operation ASN1 script. The different operations which can be received are:
 - RO-Invoke operation "Sending-of-HI1-Notification" (HI1 interface);
 - RO-Invoke operation "Sending-of-IRI" (HI2 interface);
 - RO-Invoke operation "Circuit-Call-Related-Services" (HI3 interface);
 - RO-Invoke operation "No-Circuit-Call-Related-Services" (HI3 interface);
 - RO-Invoke operation "Sending-of-TETRA-Data" (HI3 interface);
 - RO-Invoke operation "Sending-of-GPRS-Data" (HI3 interface).

In case of error, the ASE_HI acts depending on the reason of the error or problem:

- In accordance with the rules defined by [35] to [37], an RO_Error is sent in case of unsuccessfully operation at the application level. The Error cause provided is one among those defined by the ASN1 script of the relevant operation.
- In accordance with the rules defined in [35] to [37], an RO_Reject_U/P is sent in case of erroneous component. On receipt of an erroneous component, the ASE_HI acts as described in [35] to [37].

C.2.3 Data link management

This function is used to establish or release a data link between two peer LI_Applications entities (MF and LEMF).

Depending on a per destination address configuration data, the data link establishment may be required either by the LEMF LI_Application or by the MF LI_Application.

C.2.3.1 Data link establishment

To request the establishment of a data link toward a peer entity, the LI_Application provides, among others, the destination address of the peer entity (implicitly, this address defined the protocol layers immediately under the ASE_HI: TCP/IP, X25, ...). On receipt of this request, the ASE_HI request the establishment of the data link with respect of the rules of the under layers protocol.

As soon as the data link is established, the requesting LI_Application initiates an authentication procedure:

- the origin LI_Application requests the ASE_HI to send the class 2 RO-Invoke operation "Sending_of_Password" which includes the "origin password" provided by the LI_Application;
- the peer LI-Application, on receipt of the "origin password" and after acceptance, requests to its ASE_HI to send back a RO-Result. In addition, this destination application requests the ASE_HI to send the class 2 RO-Invoke operation "Sending_of_Password" which includes the "destination password" provided by the LI_Application;
- the origin LI-Application, on receipt of the "destination password" and after acceptance, requests to its ASE_HI to send back a RO-Result. This application is allowed to send data;
- after receipt of the RO_Result, this application is allowed to send data.

In case of erroneous password, the data link is immediately released and an "password error indication" is sent toward the operator.

Optionally a *Data link test* procedure may be used to verify periodically the data link:

- When no data have been exchanged during a network dependent period of time toward an address, (may vary from 1 to 30 minutes) the LI_Application requests the ASE_HI to send the class 2 RO-Invoke operation *Data-Link-Test*.
- The peer LI-Application, on receipt of this operation , requests to it's ASE_HI to send back a RO-Result.
- On receipt of the Result the test is considered valid by the LI_Application.
- If no Result is received or if a Reject/Error message is received, the LI_Application requests the ASE_LI to release the data link and send an error message toward the operator.

C.2.3.2 Data link release

- The End of the connection toward the peer LI_Application is under responsibility of the LI_Application. E.g, the End of the connection may be requested in the following cases:
 - When all the data (IRI, ...) has been sent. To prevent unnecessary release, the datalink may be released only when no LI_Application data have been exchanged during a network dependent period of time.
 - The data link is established when a call is intercepted and released when the intercepted call is released (and all the relevant data have been sent).
 - For security purposes.
 - For changing of password or address of the LEMF/IIF.
 - Etc.
- To end the connection an LI_Application requests the ASE_HI to send the class 2 RO-Invoke operation "End_Of_Connection".
- The peer LI-Application, on receipt of this operation , requests to it's ASE_HI to send back a RO_Result.
- On receipt of the Result the LI_Application requests the ASE_LI to release the data link.
- If no Result is received after a network dependent period of time, or if a Reject/Error message is received, the LI_Application requests the ASE_LI to release the data link and to send an error message toward the operator/administrator.

Annex D (informative): Overview description for CC link and IRI delivery - state model

This informative annex describes under which conditions the different record types are sent. The general rule is to apply a best-effort approach. This means that events and data are handled according to standard protocols for telecommunications. This annex is not intended to define any additional or different requirements from what is stated in the main text and normative annexes.

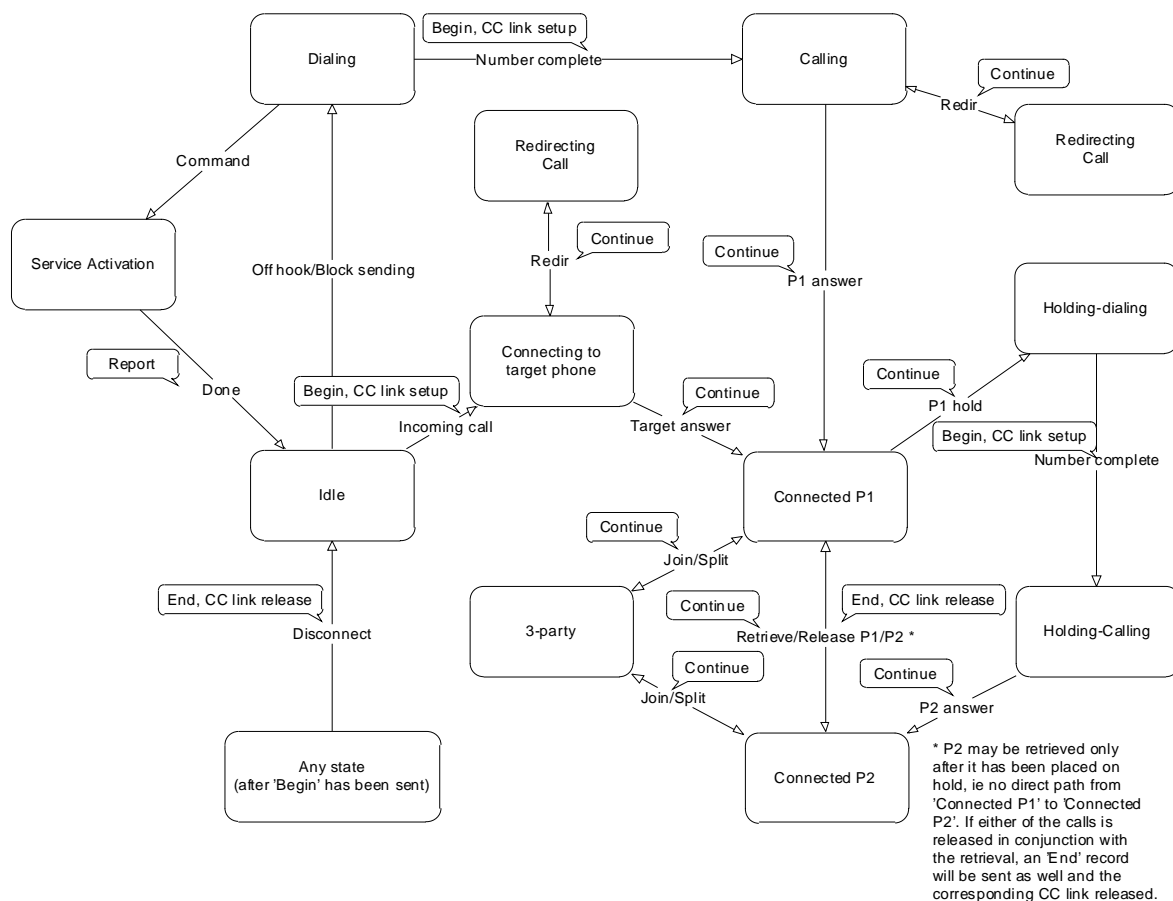
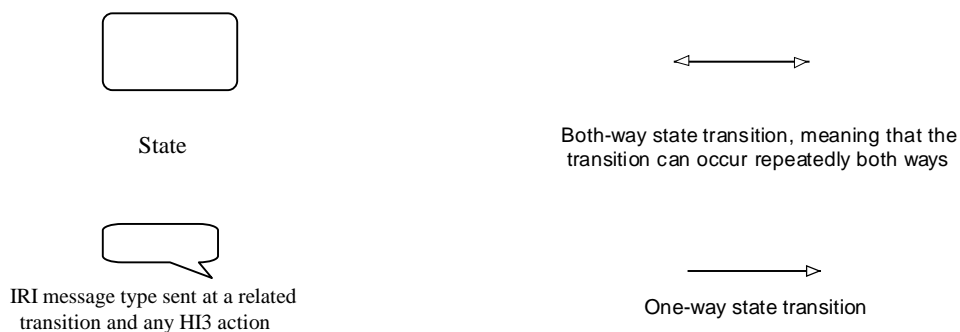

Figure D.1: Overview state model for CC link operations and IRI delivery



In order to further illustrate how state transitions and message sending interact, a few examples of specific traffic cases are given below.

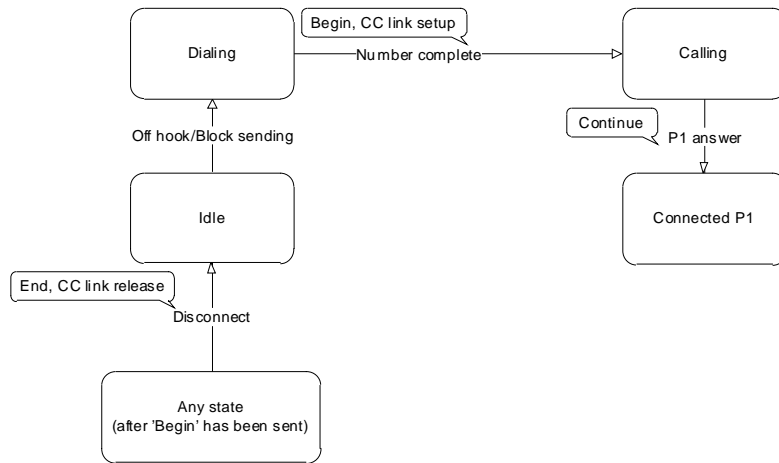

Figure D.2: A Simple Originating Call

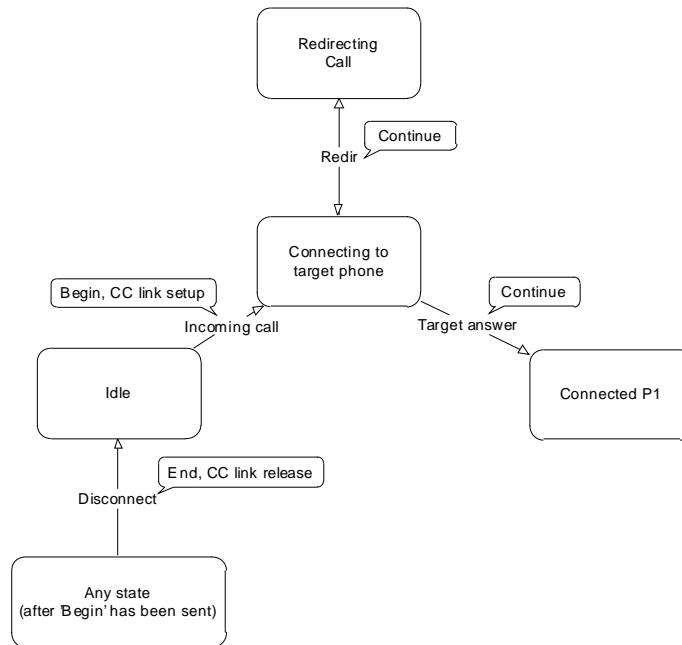

Figure D.3: Incoming Call with Redirection

The figure above describes the case of interception continuing on call transfer

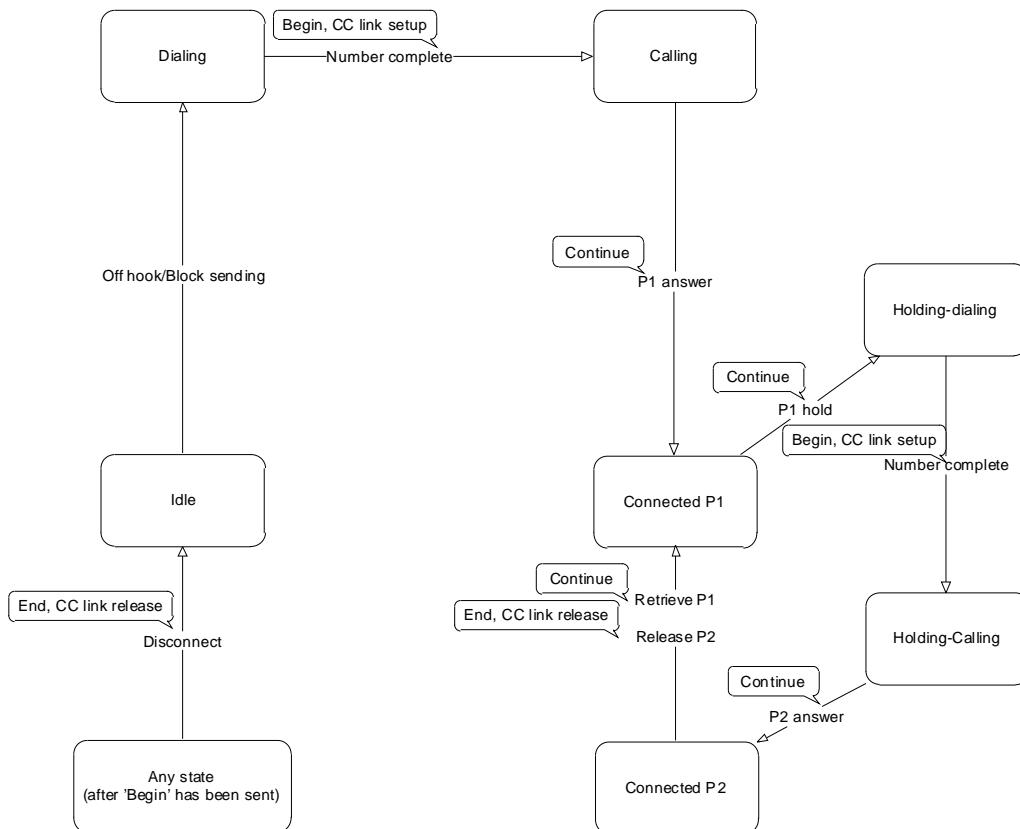

Figure D.4: Originating Call with Enquiry

Annex E (informative): Message Sequence Diagrams, IRI content

E.1 General remarks

The tables and message sequence diagrams (scenarios) of this section are typical examples, showing which parameters shall be included in the IRI records, and when the records shall be sent out to the LEA, for different call phases, call configurations and the invocation of supplementary services. The purpose of this annex is, to supplement and clarify the procedures and the use of parameters, which are specified in the main body and the normative annexes of the present document. These normative parts have precedence, in case of ambiguities.

A general principle for handling complex call configurations is, to break down the scenarios for LI related tasks into several sub-scenarios, which are ideally identical for parts of basic calls or other "standard" call situations. This reduces significantly the complexity of specifying and realizing the LI related tasks. As a consequence, the scenarios below contain in many cases just a remark to another scenario, with the applicable sequence, see example below.

EXAMPLE: Call Forwarding on No Reply (CFNR) is active for a target (party B).

- 1) An incoming call is, after a time-out, released at the target's access, but forwarded by the exchange. The sequence up to the release is handled like a call released by B during ringing.
- 2) The following set up of the forwarded call to a party C is handled in the same way as for immediate forwarding, e.g. CFU.

Both transactions can be treated independently of each other, a specific, new sequence for CFNR is not needed.

The tables and scenarios of this annex contain several typical cases, they are not covering all possible combinations. They are structured into clauses as follows:

Basic calls

E.4 Originating target, basic call

E.5 Terminating target, basic call

Call with supplementary services being invoked

E.6 Originating target call, invocation of LI relevant services

E.7 Terminating target call, invocation of LI relevant services

E.8 Target actions during a call in progress

E.9 Three Party Service (3PTY)

E.10 Add on conference (CONF)

E.11 Target exchange receives notification related to other party

Subscriber controlled input (SCI)

E.12 Service Activation (not call related)

E.13 Service activation / invocation during a call

Unsuccessful calls

E.14 Unsuccessful calls from target (originating), IRI-BEGIN record sent

E.15 Unsuccessful calls from / to target, IRI-BEGIN record not sent

E.2 Remarks to tables

Within the tables, the parameters of an IRI record, which are significant for the specific case are indicated. They depend, except for the mandatory parameters, of the type of a target call. The order of the IRI parameters is not fixed. The complete set of parameters, which may be part of an IRI record, follows from the general rules of subclauses 8.5 and 10.3. The parameter notation uses the ASN.1 definitions of Annex A.

Unless otherwise stated, the tables are applicable to all kinds of originating or terminating accesses, like ISDN and analogue subscribers. Restrictions or differences may be mentioned in the row "remarks" or within additional text.

Mapping of parameters originated from other signalling systems than DSS1 or ISUP shall follow existing interworking specifications.

Only parameters and signals, which are available from the standard signalling procedures shall be included; no additional procedures need to be used for LI to obtain parameters, which are not available by default. For example, no request for a missing CLI need to be made, even if the signalling system would allow it.

Regarding the accuracy of the time stamp value of a record, it may be determined at any point in time during the period between the detection of an event and the sending of the related record.

E.3 Remarks to scenarios

The included scenarios are examples. They show successful LI invocations within a local exchange; exceptional cases are not included. In case of ambiguities, the text of the main body and the normative annexes shall have priority.

The indicated call handling messages do in general not base on a specific protocol; however, in several cases, protocol specific information needs to be mentioned; in these cases, the DSS1 functional access protocol is used, because it is a kind of superset standard of protocol features. Within the figures, such cases are indicated by using DSS1 protocol message names in capital letters. Message sequences for other protocols, like for analogue accesses, should be derived from the specified sequences.

The scenarios do not show all signalling protocol messages. Emphasis is on those messages, which are significant for or related to IRI records and CC link events.

The IRI record parameters, which are indicated as an additional information in the scenarios, are limited to significant ones for a given case; e.g. parameters, which are mandatory, like the LIID, data & time, etc., are not explicitly mentioned. The parameter names use logical names, as defined in the tables of clause 8, instead of the exact ASN.1 notation.

It is not required, that, depending on the actual access or network protocols, and the call configuration, e.g. purely local calls, or calls via other exchanges, for the same actions of a target or another party, exactly the same sequences are resulting.

The master configuration, for decisions, which parameters ought to be included in IRI records, are transit calls using ISDN user part signalling. This means for example, that the information, which can be provided by such calls, shall also be available in case of purely local calls. As described above, the individual IRI records, which carry a certain information, may vary.

As a general rule, intercept related information is transmitted to the LEMF within an IRI record, when it gets first available. Identical parameters are in the scenarios not repeated in succeeding records, unless their content or value has changed; however, an implementation may decide to repeat information, which has already been sent, e.g. in order to avoid the need for a memory of already sent parameters.

With respect to the CC links in case of multi party calls, the options "CC links for active and non-active calls" is shown (option A).

In general, the scenario figures contain one or more pictures, depicting the actual configuration of the target and the other party(ies) within a call, and the target's call state.

Functional entities used within the scenarios:

- Target terminal: Equipment of the interception subject, which originates or terminates an intercepted call.
- Orig. / term. SF_T: Switching function of the target, containing the IIF; within these examples, the SF_T is assumed to be a fixed ISDN network local exchange.
- Orig. / term. SF_P: Switching function of the other party; within these examples, the SF_P is assumed to be a fixed ISDN network local exchange.
- Other party: Equipment of the other party(ies), which originates or terminates a call, in which the target is involved.
- LEMF HI2 (IRI): LEMF port, receiving IRI.
- LEMF HI3 (CC): LEMF port, receiving the content of communication (CC links).

NOTE: An incoming message to any functional entity causes in general one or more outgoing messages; in case of several outgoing messages, the order of sending them is purely implementation dependent, the figures do not intend to specify a fixed sequence.

E.4 Originating target, basic call

This section concentrates on the description of basic calls, originated by the target; however, the IRI record tables depict partly also parameters, which can be used in conjunction with the invocation of supplementary services.

E.4.1 Initial LI procedures

This subclause includes the procedure until the point in time, when the local exchange of the target (SF_T) sends an IRI-BEGIN record, and sets up a CC link.

Corresponding transition in state model: *Begin, CC link set up* (the state model shows the special case of en-bloc dialing).

The IRI-BEGIN record constitutes the first record of an originating or terminating call.

NOTE: The exact point of sending the IRI-BEGIN record may depend on national regulations, and on the implementation of the IIF. It may e.g. be sent immediately when connecting dial tone, or only, when starting routing within the SF_T. Irrespective of the point in time of sending the IRI-BEGIN record, it shall be possible to send an IRI-REPORT record, if a call is released at an earlier point in time.

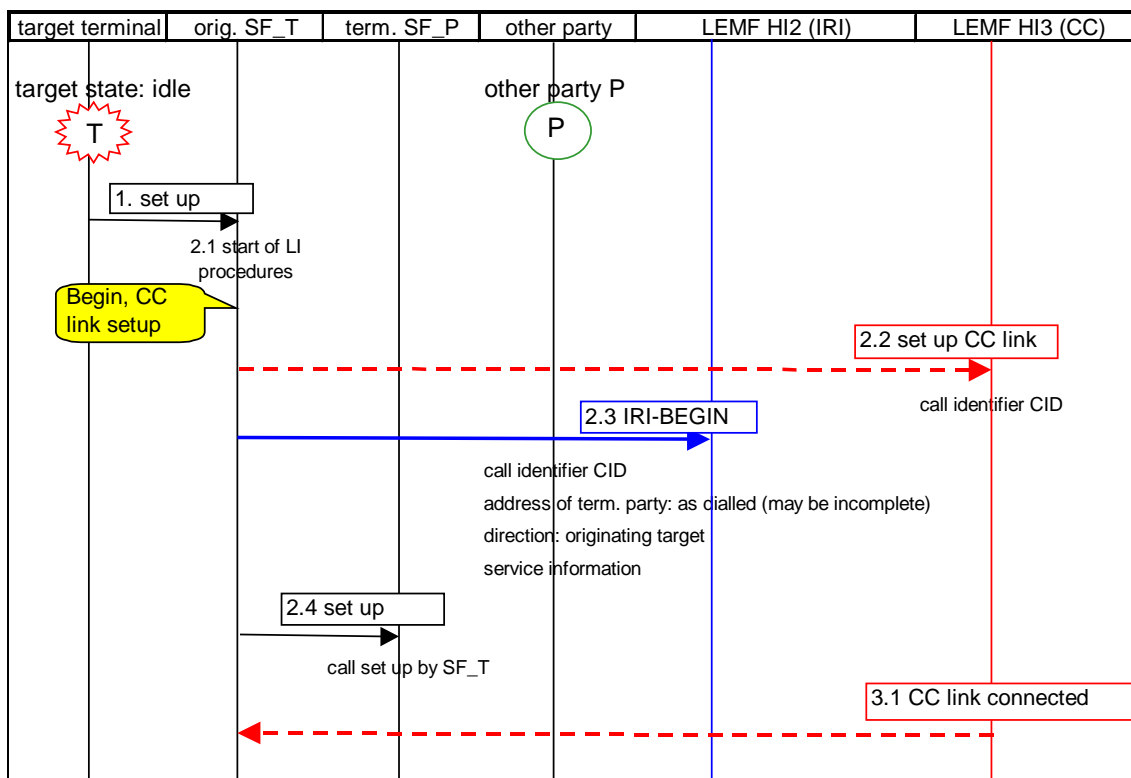

Figure E.1: Start of call originating from target

Table E.1: IRI-BEGIN record content for call originating from target

IRI - BEGIN record	
parameter name	remarks / parameter details
lawfullInterceptionIdentifier	identifying the LI activation (LIID)
callIdentifier	call identifier of originating target call
timeStamp	at reception of set up request by target exchange
nature-Of-The-intercepted-call	gSM/ISDN/PSTN-circuit-call
intercepted-Call-Direct	originating-Target
intercepted-Call-State	setUpInProgress
partyInformation	party-Qualifier: originating-Party services-Information: BC/HLC/LLC (as available) supplementary-Services-Information (as available, e.g. CF related information, from previous forwardings, or forwarding by the target, subaddress, CUG, generic number)
partyInformation	party-Qualifier: terminating-Party calledPartyNumber (available digits, at this point in time)
callContentLinkInformation	SetUpInProgress (CC link state)

After reception of the confirmation, that the CC link has been answered, the CC link state changes to the value "callActive".

E.4.2 Set up of an additional call leg

In case of set up of a new call leg, e.g. when another call is in the *held state*, an IRI-BEGIN record as defined here is sent, i.e. a new, independent IRI transaction is set up. If the CC link option B is used ("CC links only for actually active calls"), no separate CC link is set up for this call leg, the existing CC link is used instead for transmission of the content of communication; the call identifier shall contain the CCLID value of the used CC link.

E.4.3 IRI-CONTINUE records (general)

For a Basic Call, the first IRI-CONTINUE record is sent at reception of the Answer or Connect indication.

If supplementary services are invoked, like:

- Call waiting;
- Call Forwarding.

IRI-CONTINUE records may be sent before answer or during the active phase of a call.

IRI-CONTINUE records are also used to report failures of the CC links or a CC link release by the LEMF.

Principles for sending supplementary services related IRI-CONTINUE records: When parameters as listed in subclause 8.5 are available from the call handling procedures.

The *Facility IE* shall be sent only, if it contains components being part of table 10 (subclause 8.5).

E.4.4 Answer by other party

For a Basic Call, the first IRI-CONTINUE record is sent at reception of the Answer or Connect indication (call is switched through), see Figure E.2; Alerting is not reported (for a basic call). The called party number needs only to be sent, if the number in the IRI-BEGIN record was not complete (originating target, overlap sending / receiving). In this case, the IRI-CONTINUE record shall contain the complete number.

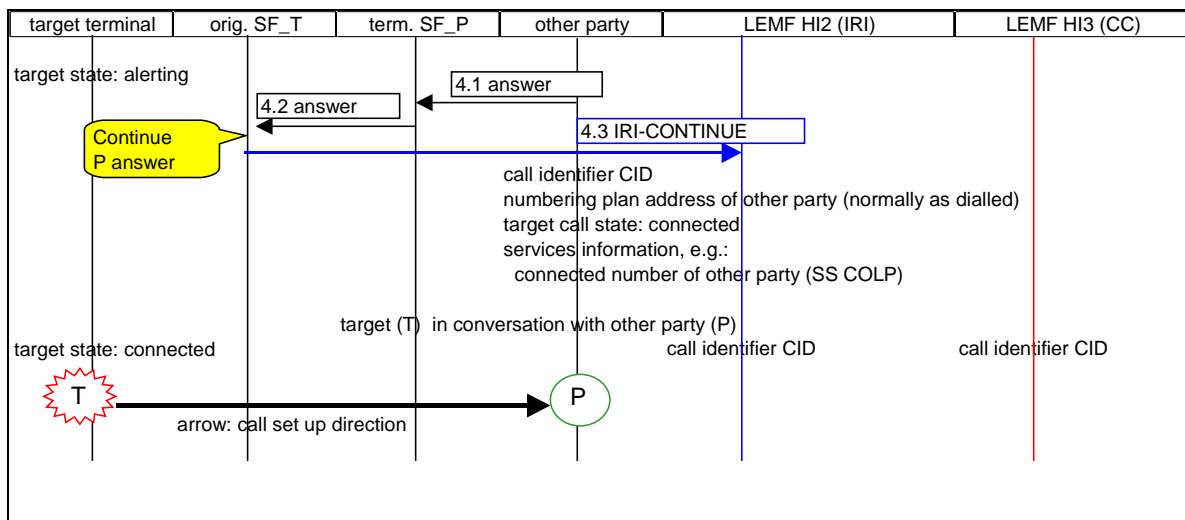

Figure E.2: Answer by other party (terminating party P)

Table E.2: IRI-CONTINUE record content during call establishment, answer indication received

IRI - CONTINUE record	
parameter name	remarks / parameter details
callIdentifier	call identifier of originating target call
timeStamp	at reception of answer indication by target exchange
nature-Of-The-intercepted-call	gSM/ISDN/PSTN-circuit-call
intercepted-Call-State	connected
SimpleIndication	only for targets, e.g.: call-Waiting-Indication (call is waiting at terminating target)
partyInformation	party-Qualifier: originating-Party services-Information: BC/HLC/LLC (if different from value in IRI-BEGIN record) supplementary-Services-Information (new information, as available)
partyInformation	party-Qualifier: terminating-Party calledPartyNumber (only if "other party": full number of other party) supplementary-Services-Information (new information, as available, e.g.: connected number (Note 2), connected subaddress, generic notification indicator)
lawfulInterceptionIdentifier	identifying the LI activation (LIID)
callContentLinkInformation	callActive (normal case)
NOTE 1: This table relates to both cases, a target being originating or terminating party.	
NOTE 2: In case of a terminating target, the connected number is only included, if it is not equal to the target identity.	

E.4.5 Call release (originating or terminating target)

In case of an unsuccessful call, an IRI-END Record is sent, if before an IRI-BEGIN record has been sent. If a target call is released before sending an IRI-BEGIN record, an IRI-REPORT record is sent instead, see clause E.15.

NOTE 1: The figure below does not show the detailed DSS1 or ISUP release sequences.

NOTE 2: The exact point of sending the IRI-END record may depend on national regulations, and on the implementation of the IIF. It may, e.g. in case of DSS1, be sent immediately when receiving / sending the RELEASE message, or when sending / receiving RELEASE COMPLETE.

The IRI-END Record is also applicable, if the released call was a call e.g. forwarded or transferred by the target.

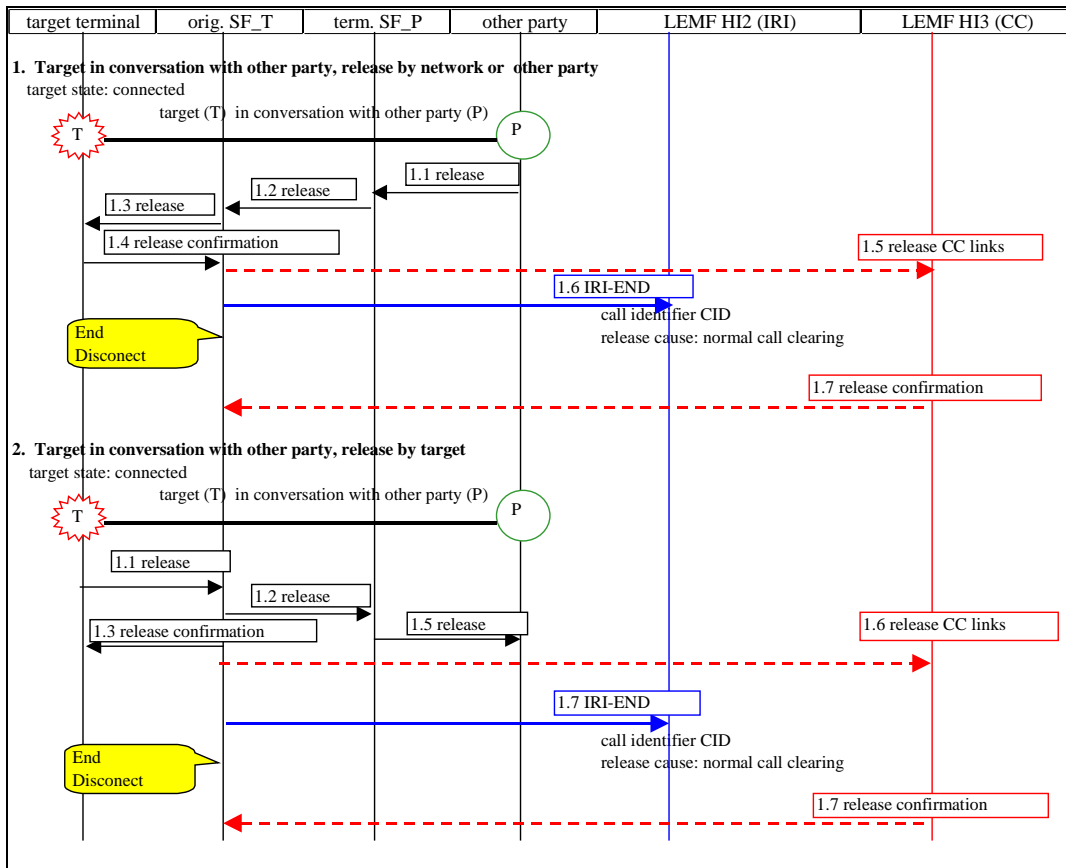

Figure E.3: Call released, release started by target or other party / network

Table E.3: IRI-END record for call released by target or by the network

IRI - END record	
parameter name	remarks / parameter details
LawfulInterceptionIdentifier	identifying the LI activation (LIID)
CallIdentifier	call identifier of originating target call
TimeStamp	at reception of release indication by target exchange
nature-Of-The-intercepted-call	gSM/ISDN/PSTN-circuit-call
Intercepted-Call-Direct	originating-Target / terminating-Target
intercepted-Call-State	idle
PartyInformation	party-Qualifier: originating-Party supplementary-Services-Information (new information, as available)
PartyInformation	party-Qualifier: terminating-Party supplementary-Services-Information (new information, as available)
release-Reason-Of-Intercepted-Call	cause value as received from signalling
CallContentLinkInformation	callReleased, release-Time, release-Reason
NOTE: This table relates to both cases, a target being originating or terminating party.	

E.5 Terminating target, basic call

E.5.1 Initial LI procedure

Procedure until point in time, when the local exchange of the target (target exchange) sends an IRI-BEGIN record, and sets up a CC link.

The IRI-BEGIN record constitutes the first record of an originating or terminating call.

NOTE: The exact point of sending the IRI-BEGIN record may depend on national regulations, and on the implementation of the IIF. It may e.g. be sent immediately when determining the target, as shown below, or only, when the call set up has been confirmed. Irrespective of the point in time of sending the IRI-BEGIN record, it shall be possible to send an IRI-REPORT record, if a call is released at an earlier point in time.

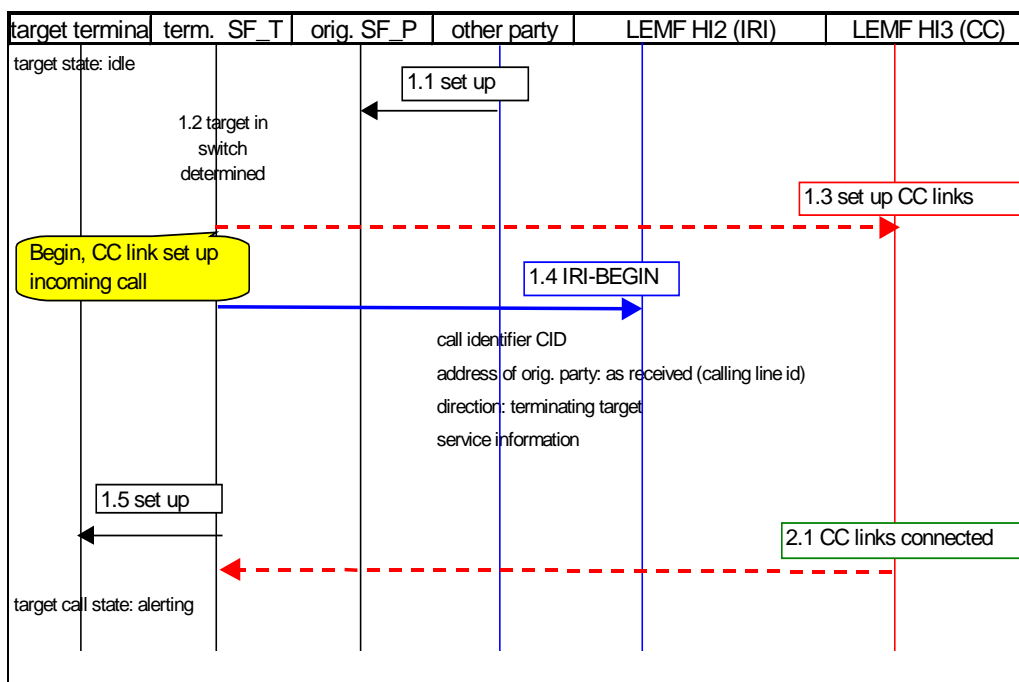

Figure E.4: Start of call terminating at target

Table E.4 includes possible parameters in the IRI-BEGIN record, including several parameters for supplementary services.

Table E.4: IRI-BEGIN record for call terminating at target

IRI - BEGIN record	
parameter name	remarks / parameter details
lawfulInterceptionIdentifier	identifying the LI activation (LIID)
callIdentifier	call identifier of originating target call
timeStamp	at reception of set up request at local exchange, term. side
nature-Of-The-intercepted-call	gSM/ISDN/PSTN-circuit-call
intercepted-Call-Direct	terminating-Target
intercepted-Call-State	setUpInProgress
partyInformation	party-Qualifier: originating-Party callingPartyNumber (as received, if available) services-Information: BC/HLC/LLC (as available) supplementary-Services-Information (as available / received, e.g. call forwarding related information), subaddress, CUG, generic number)
partyInformation	party-Qualifier: terminating-Party supplementary-Services-Information (as available, e.g. subaddress)
callContentLinkInformation	setUpInProgress

The record is sent at a set up request to the target, when it has been determined. In addition to the basic call parameters, several parameters for supplementary services are indicated in Table E.4 above. The record constitutes the first record of a terminating target call.

The BC, HLC and LLC parameters are in case of an incoming ISUP call mapped from the USI parameter, if available. Otherwise, the TMR parameter is used. This corresponds to the normal procedure for mapping of ISUP to DSS1.

If the incoming call is a forwarded call, the parameters related to the previous forwarding(s) are included in the originating party information.

After reception of the confirmation, that the CC link has been answered, the CC link state changes to the value "callActive".

Cases, in which the target invokes call forwarding immediate (e.g. CFU) are part of subclause E.7.2, Figure E.7. If CF after determination of the target access (e.g. CFNR) is active, the record as defined here is sent; before forwarding takes place, an IRI-END Record indicates the end of this first call section, and a new IRI transaction is started for the forwarded call, see subclause E.7.2, Figure E.8.

E.5.2 Answer by target

For a basic call, the first IRI-CONTINUE record is sent at reception of the Answer or Connect indication from the target.

Record content: See Table E.2.

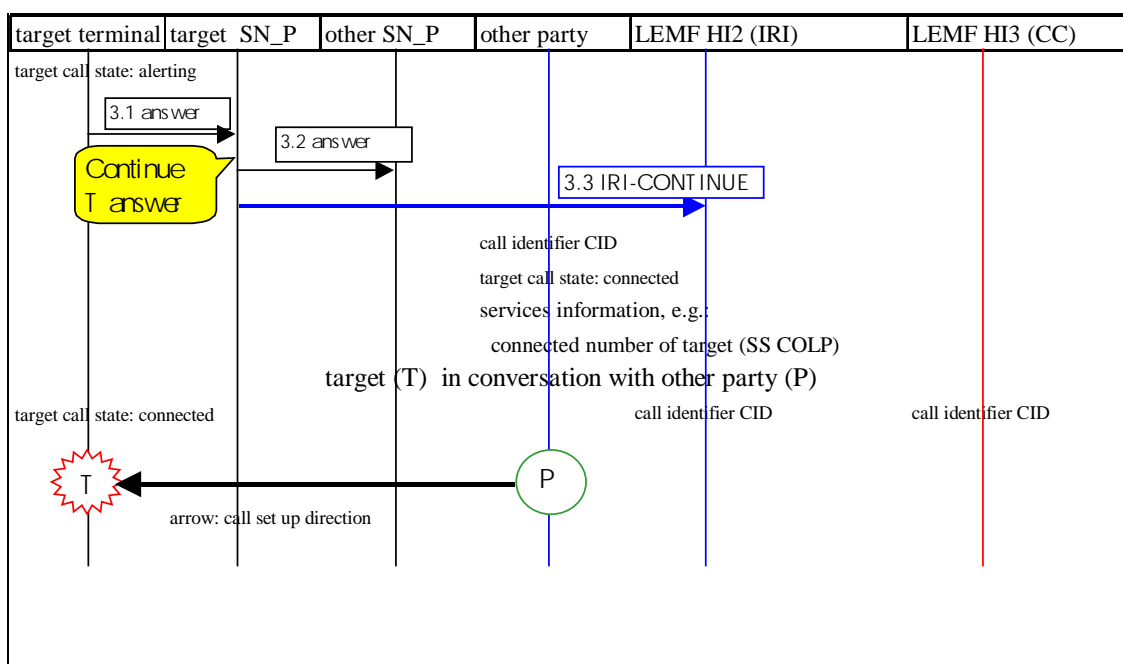

Figure E.5: Terminating call to target, answer by target

E.5.3 Call release

See subclause E.4.5.

E.6 Originating target call, invocation of LI relevant services

Several services are mentioned in the sections on basic originating target calls; in this section, specific services are considered, which are of major significance for LI.

E.6.1 Call forwarded by called party

If the called party (P1) invokes call forwarding (CF) to a party P2, the related information (*redirection number* and *call diversion information*) is reported within an IRI-CONTINUE record, see Figure E.6. It is sent at reception of the backward information, that call forwarding to P2 takes place at P1, e.g. in case of the ISUP, after receiving ACM at the exchange of target T. The other records and the CC link set up are identically to a basic call.

If the call is forwarded further by party P2, for this forwarding hop additional IRI-CONTINUE records are generated, with the same forwarding-relevant parameters. In case of ISUP signalling, the information is received by the target exchange within CPG messages.

The scenario in Figure E.6 below starts from the state, when in the target exchange the information, that P1 forwards the call, is received.

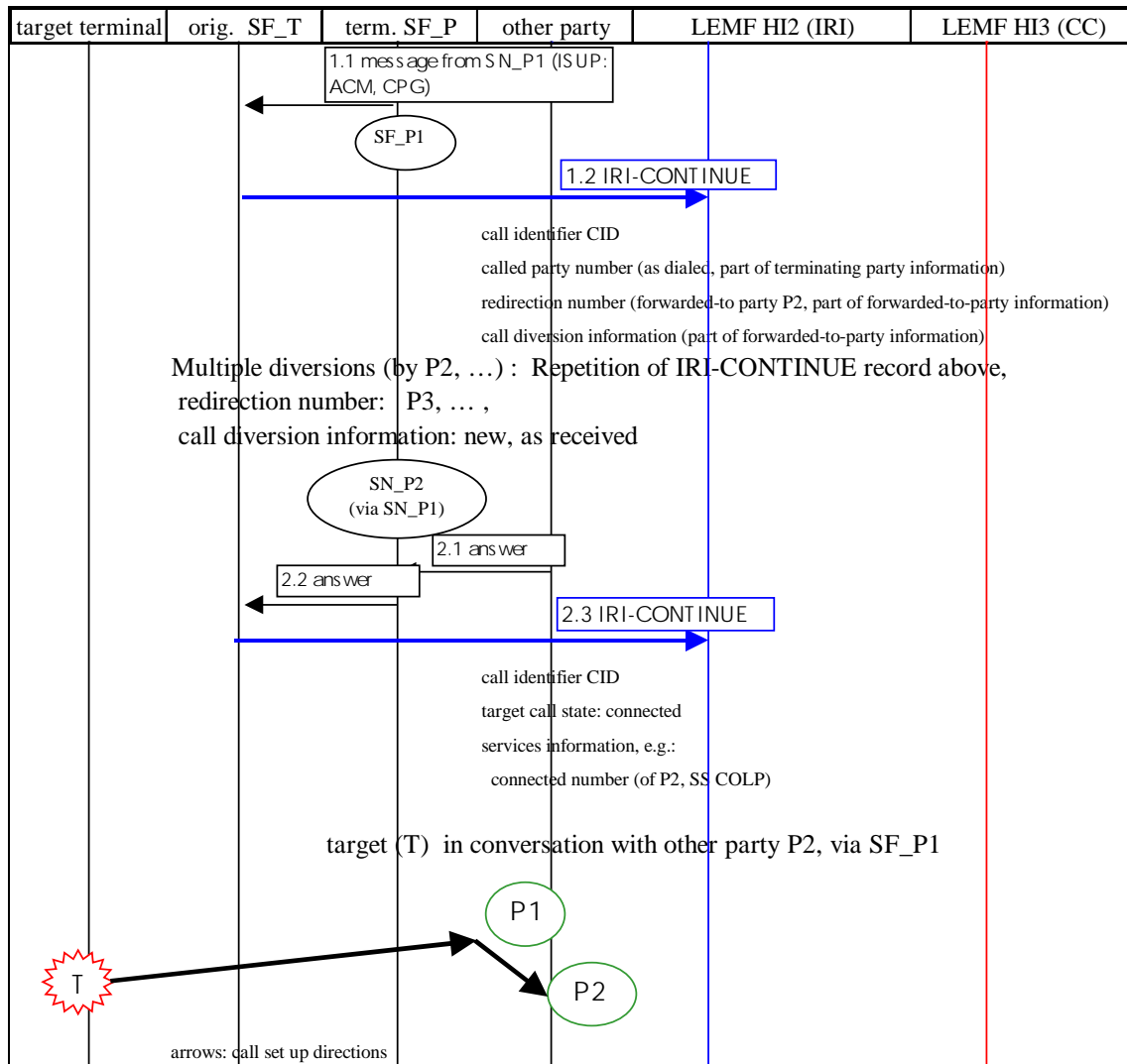

Figure E.6: Originating call from target, forwarded by called party P1 to party P2

Table E.5: IRI-CONTINUE record (1.2 in Figure E.6), call from target forwarded by called party P1

IRI - CONTINUE record	
parameter name	remarks / parameter details
lawfullInterceptionIdentifier	identifying the LI activation (LIID)
callIdentifier	call identifier of originating target call
timeStamp	at reception of answer indication by target exchange
nature-Of-The-intercepted-call	gSM/ISDN/PSTN-circuit-call
intercepted-Call-State	setUpInProgress
partyInformation	party-Qualifier: originating-Party may be missing, if no new information is available.
PartyInformation	party-Qualifier: terminating-Party calledPartyNumber (full number of called party P1) supplementary-Services-Information (new information, as available)
PartyInformation	party-Qualifier: forwarded-to-Party supplementary-Services-Information: redirection number, call diversion information
callContentLinkInformation	callActive (normal case)

E.7 Terminating target call, invocation of LI relevant services

Several services are mentioned in the sections on basic originating target calls; in this section, specific services are considered, which are of major significance for LI.

E.7.1 Terminating call at target is a forwarded call

See subclause E.5.1.

E.7.2 Call forwarded by target

Cases of immediate call forwarding, without accessing the target's terminal (e.g. CFU, CFB-NDUB):

- The first record related to the call is an IRI-BEGIN record. It contains within the PartyInformation of the forwarded-to-party the CF-relevant information (*redirection number, redirection information*), see Figure E.7.

Cases of call forwarding after accessing the target's terminal (e.g. CFNR, CD, Partial Rerouting, CFB-UDUB):

- A LI transaction (CC links, IRI records) has already been established. It is released, and simultaneously with the release of the call to the target, an IRI-END Record is sent, see Figure E.8.
- The call diversion procedure leads to a new LI transaction, with an IRI-BEGIN record as specified above, for immediate forwarding.

The connected line identity (COL-parameter) may be received in the standard way from the final destination of the call within the answer (or connect) message; it is included in the related IRI-CONTINUE record.

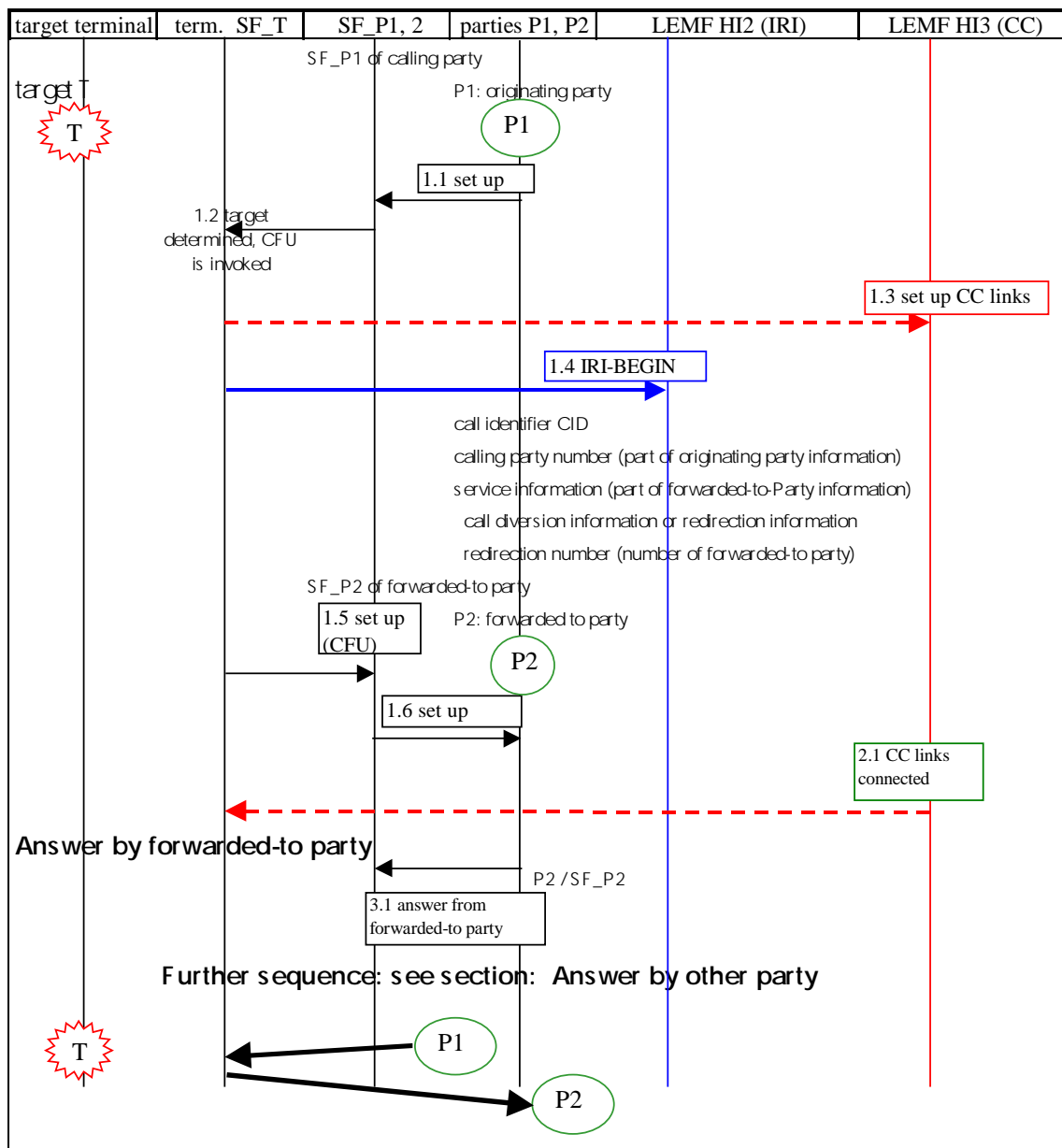

Figure E.7: Target invokes call forwarding unconditional (CFU) to a party P2

Table E.6 includes parameters in the IRI-BEGIN record; the call forwarding related information is part of the forwarded-to-Party information; the parameter "original called number" shall not be included, if it is identical to the target identity.

Table E.6: IRI-BEGIN record (1.4 in Figure E.7) for call forwarded immediately by target

IRI - BEGIN record	
parameter name	remarks / parameter details
lawfulInterceptionIdentifier	identifying the LI activation (LIID)
callIdentifier	call identifier of originating target call
timeStamp	at reception of set up request at local exchange, term. side
nature-Of-The-intercepted-call	gSM/ISDN/PSTN-circuit-call
intercepted-Call-Direct	terminating-Target
intercepted-Call-State	setUpInProgress
partyInformation	party-Qualifier: originating-Party (Party P1) callingPartyNumber (as received, if available) services-Information: BC/HLC/LLC (as available) supplementary-Services-Information (as available / received, e.g. call forwarding related information), subaddress, CUG, generic number)
partyInformation	party-Qualifier: terminating-Party (target T) supplementary-Services-Information (as available, e.g. subaddress)
partyInformation	party-Qualifier: forwarded-to-Party (Party P2) supplementary-Services-Information: redirection number, call diversion information, ...
callContentLinkInformation	setUpInProgress

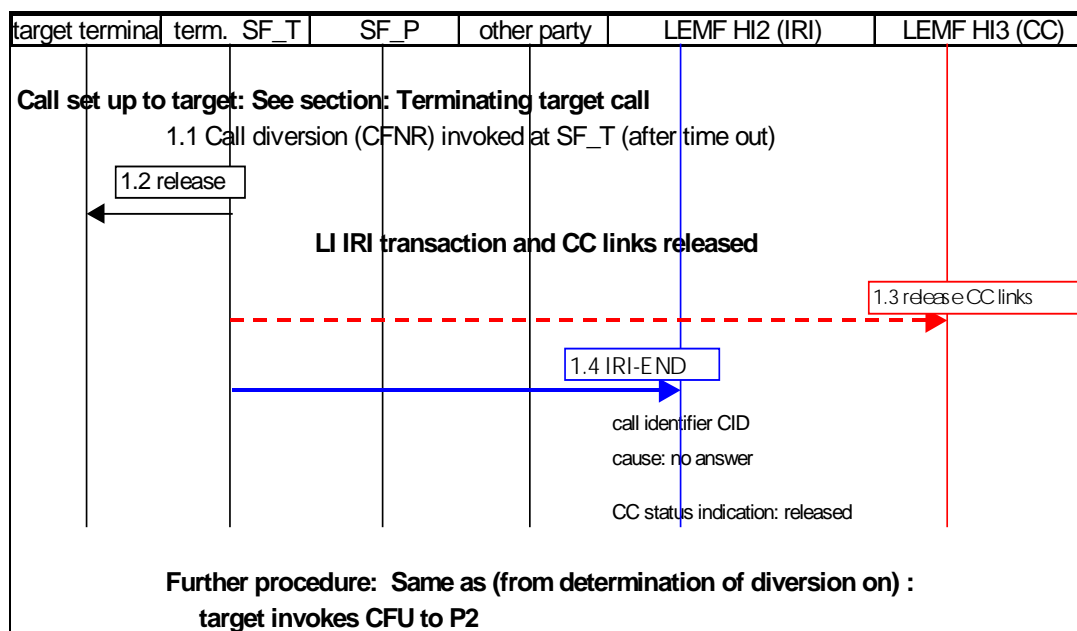

Figure E.8: Target invokes call forwarding on no reply (CFNR) to a party P2

E.7.3 Target invokes Call Waiting (CW)

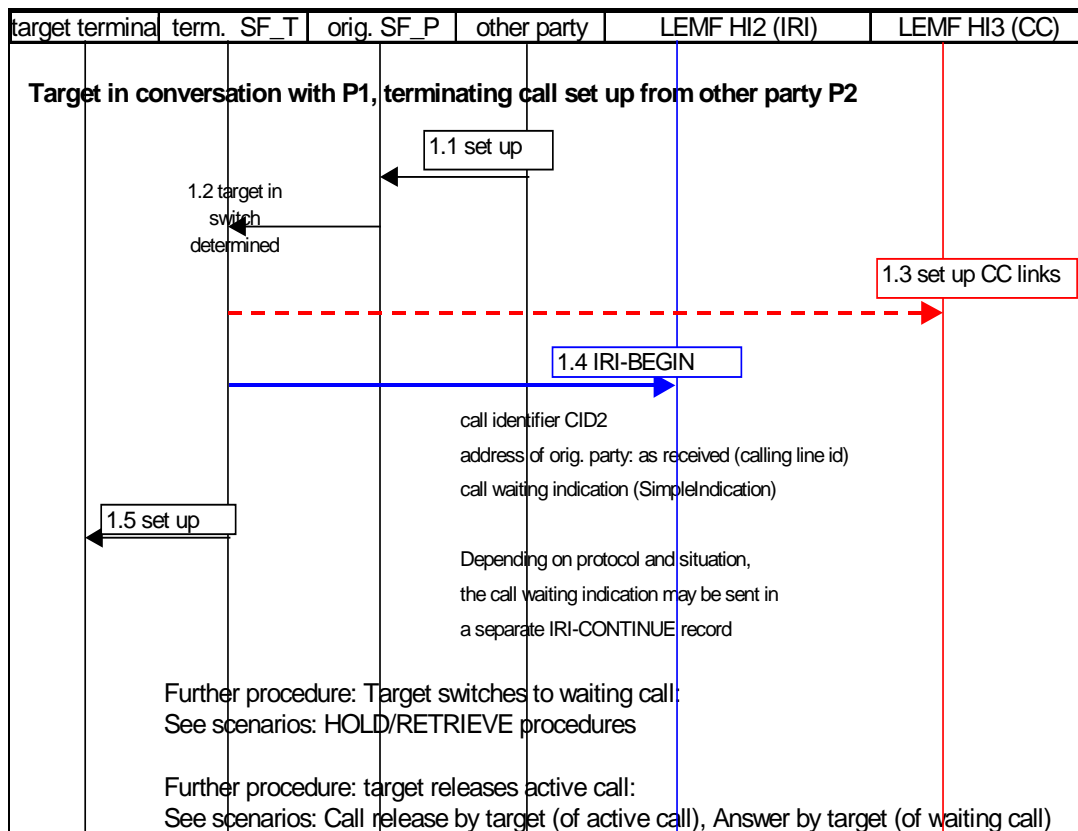

Figure E.9: Terminating target call, Call Waiting invoked by target

E.8 Target actions during a call in progress

Several kinds of actions, which a target may perform during a call, are reported via the parameter *SimpleIndication*. In general, an IRI-CONTINUE record shall be generated, when one of the reportable actions is detected. The scenarios below illustrate the actions HOLD and RETRIEVE.

E.8.1 Call HOLD by target

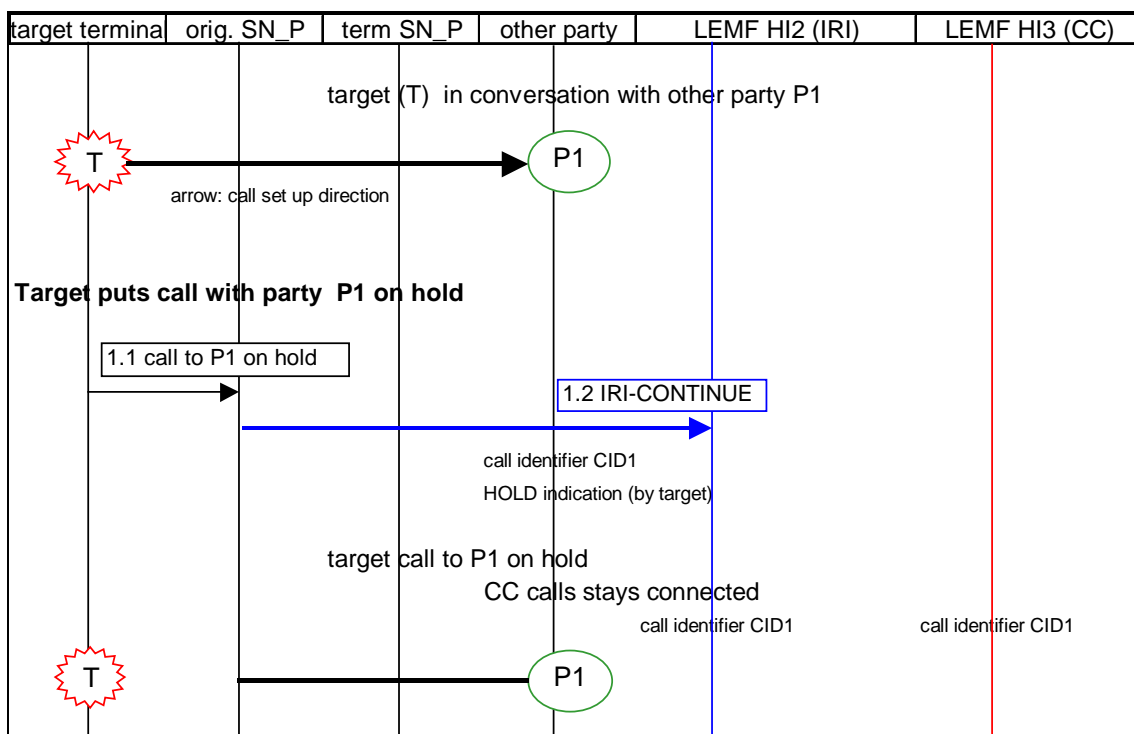

Figure E.10: Target puts a call on hold

Further actions of the target within the held state are described in other sections. For example, the set up of an additional call leg is treated like the set up of a call from the idle state, see clause E.4, and subclause 10.4, related to CC link options A/B (CC links for all calls / only for actually active calls).

E.8.2 Call RETRIEVE by target

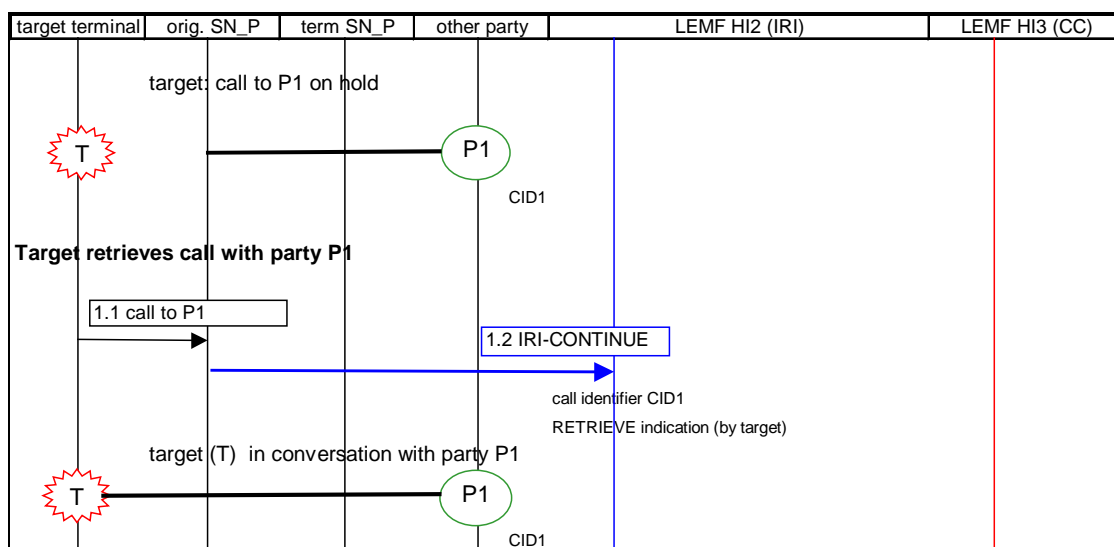

Figure E.11: Target retrieves a held call

In case of CC link option B ("CC links only for actually active calls"), the CCLID value of the call identifier shall point to the CC link, which is used by the retrieved call leg.

E.9 Three Party Service (3PTY)

This section describes procedures, which may appear during the use of the 3PTY service. Emphasis is on those actions, which are specific to the 3PTY service. With respect to preceding of succeeding actions, which are identical to basic procedures (including HOLD and RETRIEVE), an according reference is given.

The 3PTY specific actions are in general reported within IRI-CONTINUE records. The parameter *partyInformation* related to the target (originating or terminating party) contains within its *supplementary-Services-Information* parts the relevant information.

The figures base on the 3PTY service as defined for ISDN DSS1 users, including the operations of the functional protocol. The corresponding actions of other protocols, e.g. analogue or ISDN keypad users, shall be mapped to the DSS1 functional protocol operations, unless another ETSI standardized protocol is used, which contains corresponding operation definitions (like the GSM protocols). The call identifiers CID1, 2 map to the DSS1 call references CR1, 2.

E.9.1 Target establishes Three Party Conference (3PTY)

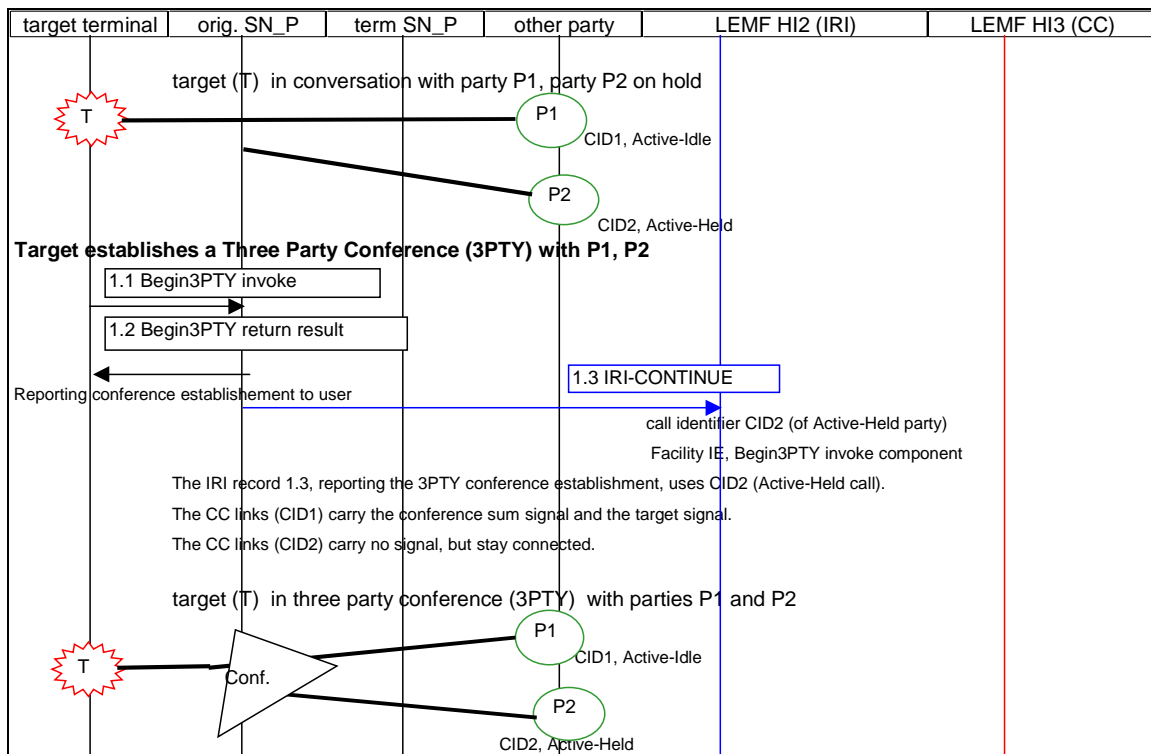

Figure E.12: Target establishes a Three Party Conference with parties P1, P2

E.9.2 Target: Private communication with Active-Idle party

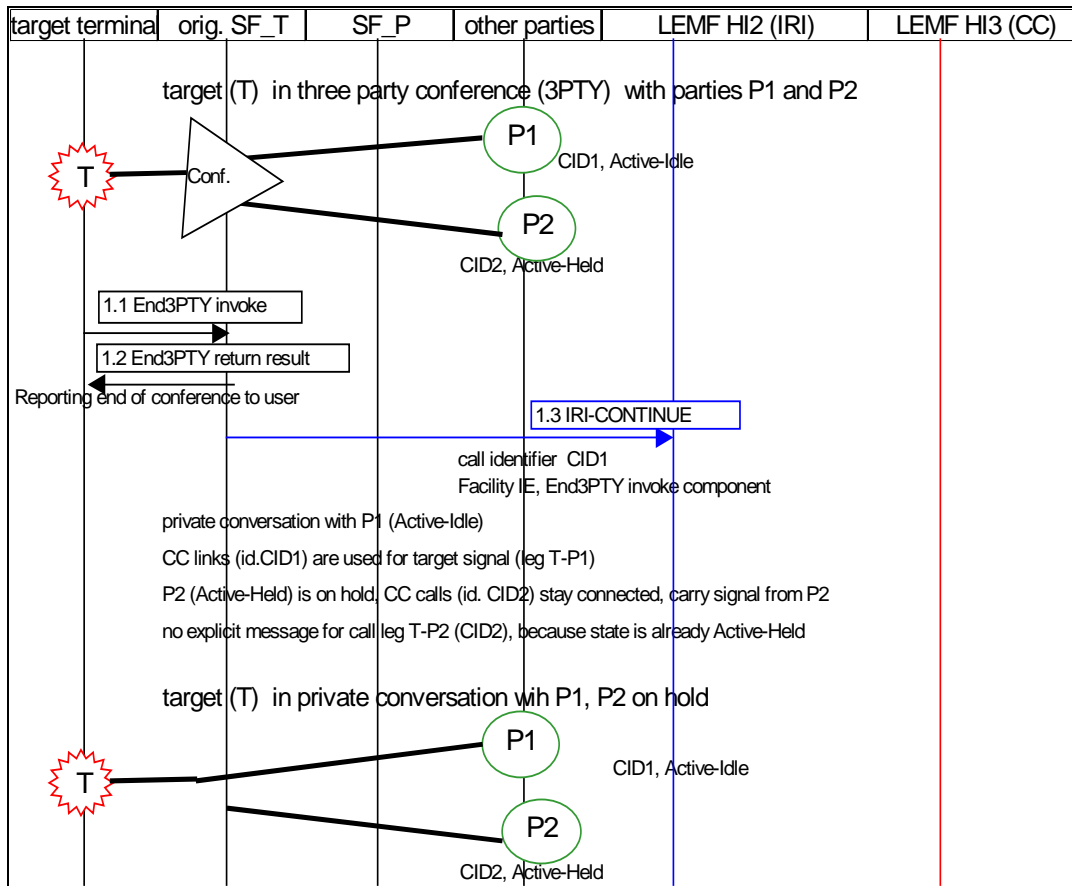

Figure E.13: 3PTY service, target switches to a private conversation with the Active-Idle party (P1)

E.9.3 Target: Private communication with Active-Held party

In principle, the same scenario as above, for a private communication with the Active-Idle party applies; the call identifier for the appropriate call leg, CID2, is used. After this procedure, a state reversal takes place: P1 becomes the Active-Held party, P2 becomes the Active-Idle party. The related procedures are identical to the procedure "target puts call with P1 on hold", followed by the procedure "target retrieves call with party P2".

E.9.4 Release of 3 PTY conference by Active-Held party

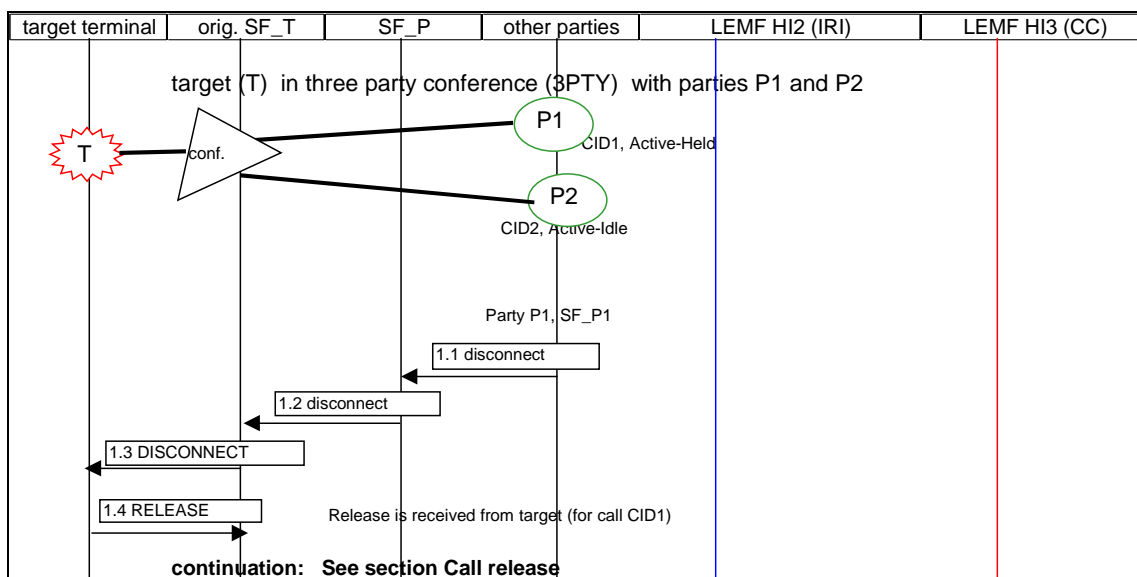

Figure E.14: 3PTY service, Active-Held party (P1) releases

E.9.5 Release of 3 PTY conference by Active-Idle party

In principle, for release by the Active-Idle party (P2), the same scenario as above, for release by the Active-Held party applies. After this procedure, a state change takes place: P1 becomes the Active-Idle party. The related procedure is identical to the procedure "target retrieves call with party P1".

E.10 Add on conference (CONF)

This section describes procedures, which may appear during the use of the Add On Conference service (CONF). Emphasis is on those actions, which are specific to the CONF service. With respect to preceding or succeeding actions, which are identical to basic procedures (including HOLD and RETRIEVE), an according reference is given.

The CONF specific actions are in general reported within IRI-CONTINUE records. The parameter *partyInformation* related to the target contains within its *supplementary-Services-Information* parts the relevant information.

For the following sections, see also reference [19]. The term "remote user" is used below for the conferee, i.e. the passive conference participant.

The text and figures base on the CONF service as defined for ISDN DSS1 users, including the operations of the functional protocol. The corresponding actions of other protocols, e.g. analogue or ISDN keypad users, shall be mapped to the DSS1 functional protocol operations, unless another ETSI standardized protocol is used, which contains corresponding operation definitions (like the GSM protocols); see also subclause E.10.9.

Subclauses E.10.1 to E.10.7 describe the procedures using option A, i.e. for each call leg, and the connection to the conference device, separate CC links are set up. Subclause E.10.8 describes the differences, when using option B.

E.10.1 Mapping of PartyId / Conferenceld to call identifiers

The call identifiers of the target call legs, which participate in a conference, have to be mapped to the PartyIds / ConferenceIds, because in several operations these identities are used by the conference procedures for identification of the remote users.

The mapping of ConferenceId / PartyId to a call identifier is performed using the first message for a call, which acknowledges the request to connect the call to a conference: this is a FACILITY message to the served user (target), containing a facility IE with the *beginCONF return result component* (for the case of beginning a conference from an active call) or the *AddCONF return result component* (for adding a party to an existing conference device), respectively. The call references of these messages identify the call leg, they can be used as a link to the call identifier.

The call reference of a call leg is released after adding the leg to the conference, but its call identifier (CID1, 2 ...) shall be kept. The call reference of the first message setting up the conference (containing the *beginCONF invoke component*) is not released. It maps always to the call identifier CID-CONF.

E.10.2 Beginning a conference from the Idle call state

For beginning a conference from the Idle call state, a SETUP message is sent by the target (call reference CR-CONF), with a *beginCONF invoke component*. After sending the acknowledgement to the served user (*beginCONF return result component* within a CONNECT message), the *beginCONF invoke component* shall be included in an IRI-BEGIN record. The component shall contain the ConferenceId parameter. A new call identifier value is assigned (CID-CONF), identifying the connection target - conference device (used for the conference sum signal). The reception of the *beginCONF invoke component* by the LEMF indicates the successful CONF establishment; unsuccessful attempts (resulting at the user access in *return error* or *reject* components) need not to be reported (general principle, see also subclause 10.3).

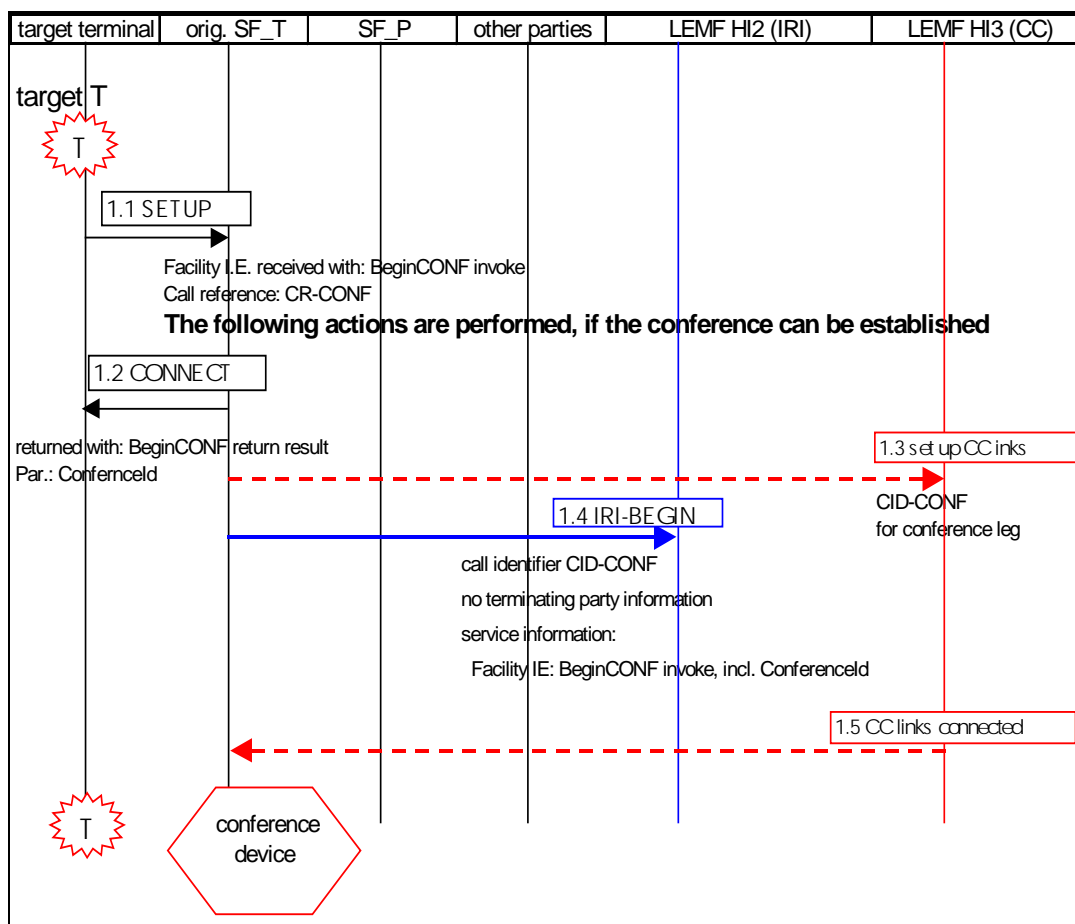

Figure E.15: Add-on Conference, target starts conference from the idle call state

E.10.3 Beginning a conference from the Active call state

For beginning a conference from the *Active call state*, a *FACILITY* message with a *beginCONF invoke component* is sent by the target, using the call reference of the active call (CR1). After sending the acknowledgement to the served user, a *beginCONF return result component* within a *FACILITY* message, the *beginCONF invoke component* shall be included in an *IRI-BEGIN record*. The component shall contain the *ConferenceId* parameter and the *PartyId* (P1) of the call leg CID1. A new call identifier value shall be assigned (CID-CONF), identifying the connection target - conference device (used for the conference sum signal).

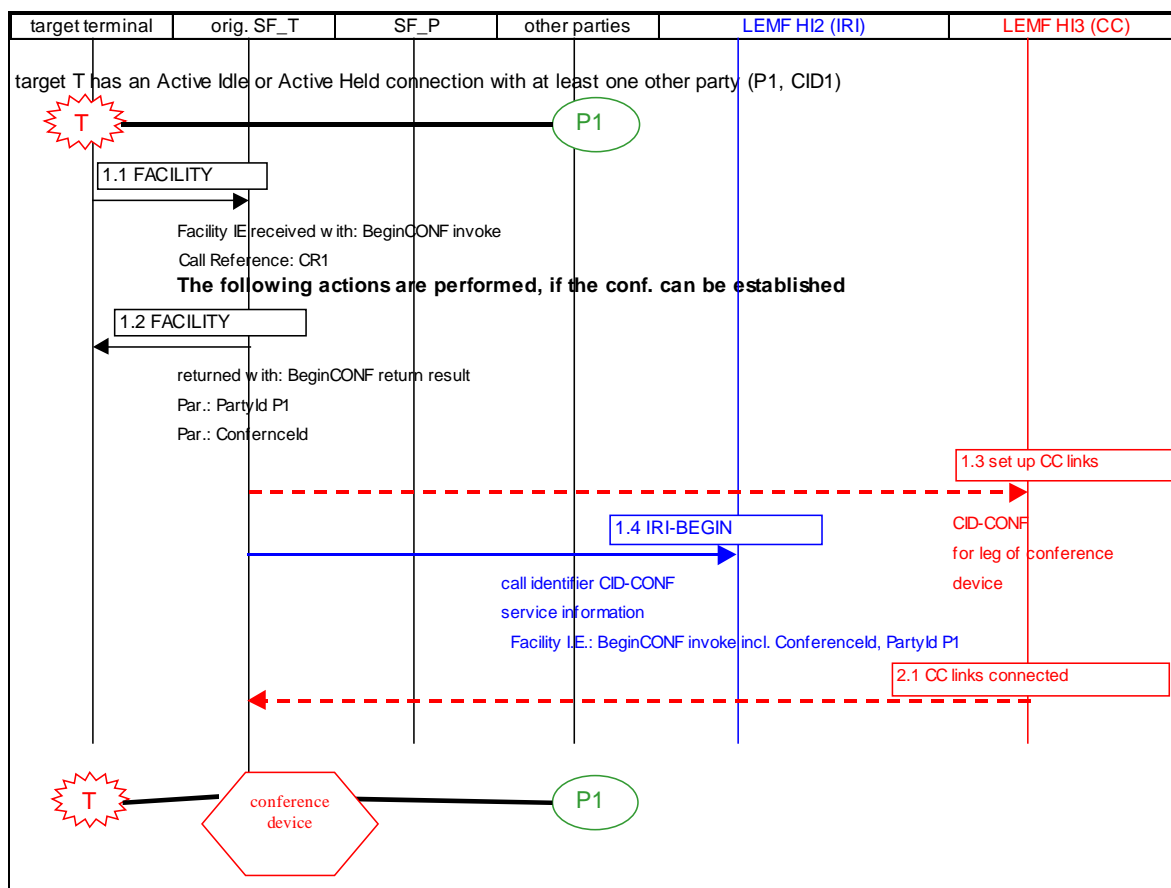

Figure E.16: Add-on Conference, target starts conference from the active call state

E.10.4 Adding a remote user

For adding a remote user (party x) to an existing conference, a *FACILITY* message with a *AddCONF invoke component* is sent by the target, using the call reference of the call to be added (CR1); it includes a *ConferenceId* parameter. The following acknowledgement (a *FACILITY* message) contains a *beginCONF return result component*, with a *PartyId* parameter. The call identifier for the added call is CID1.

NOTE: After adding the call to the conference, its call reference CR1 is released, but its call identifier CID1 is kept, for use in further records relating to this remote party connection, and to point to the CC links (they are not used, while the party is in the conference).

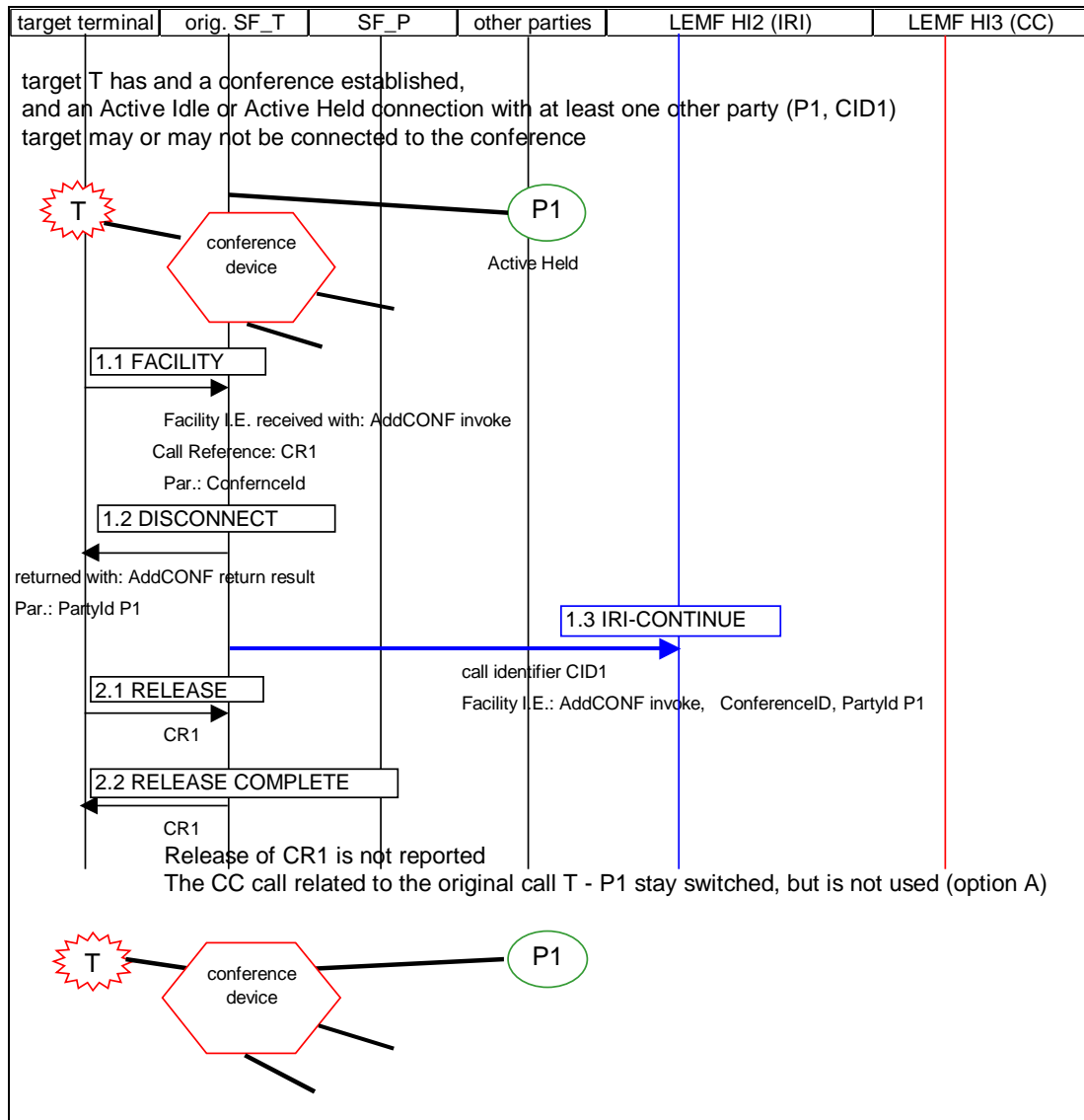

Figure E.17: Add-on Conference, target adds a call (remote user) to the conference

E.10.5 Splitting a remote user

In case of splitting a remote user, and (simultaneously) setting up a private conversation to it, a SETUP message is received from the target, using a new call reference; it contains a facility IE with a *SplitCONF invoke component*. The remote party is identified by the ConferenceId and PartyId parameters of the invoke component.

A CONNECT message is sent to the target, to confirm the operation. The *SplitCONF invoke component* shall be sent within an IRI-CONTINUE record to the LEMF.

The call identifier value used for the IRI record and the related CC links, respectively, is the value, which has been assigned to this call leg, when the call to the remote party has been originally set up (CID1).

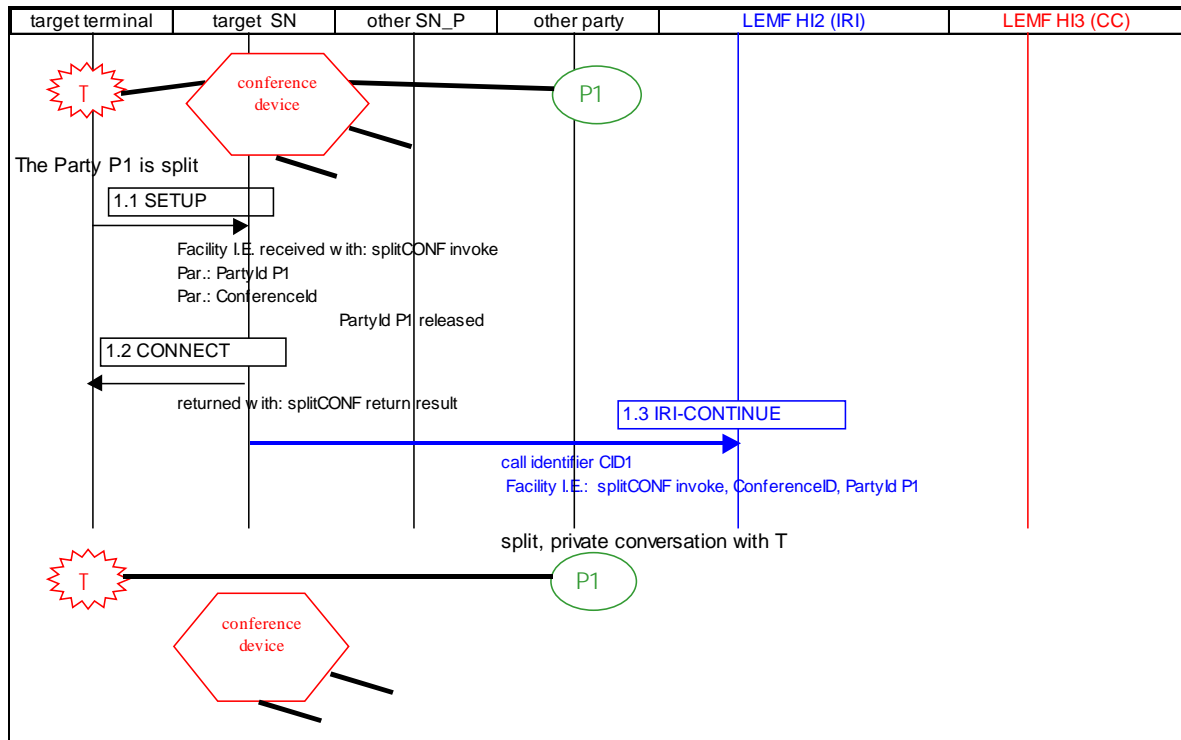

Figure E.18: Add-on Conference, target splits a call (remote user) from the conference

E.10.6 Further actions during a conference

The actions *isolate*, *reattach*, *split*, *drop* and *remote party disconnected* are reported in IRI-CONTINUE records. The applicable call identifier has to be determined via the PartyId. The figure below illustrates the procedure for isolating a party from the conference.

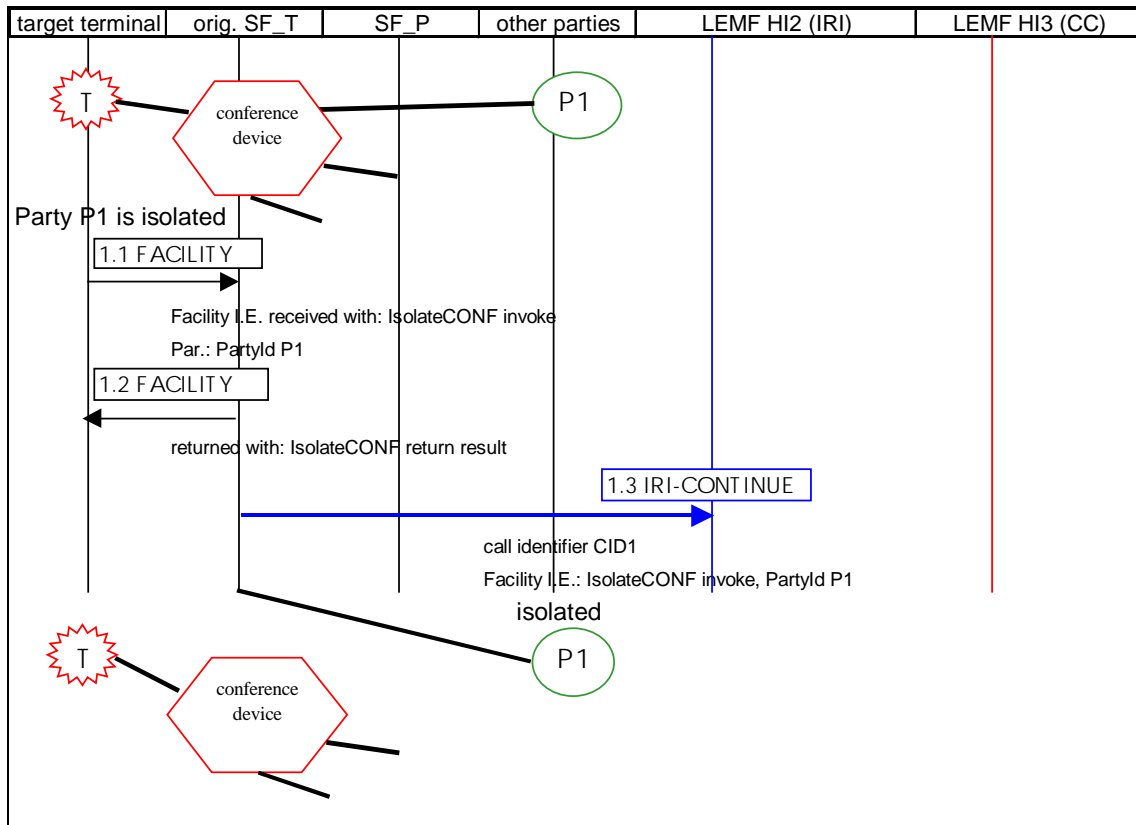

Figure E.19: Add-on Conference, target isolates a call (remote user) from the conference

E.10.7 Target clears the conference

The conference device and all call legs are released; the figure below shows the release of the conference device, the individual call legs are released in the standard way (release initiated by SF_T).

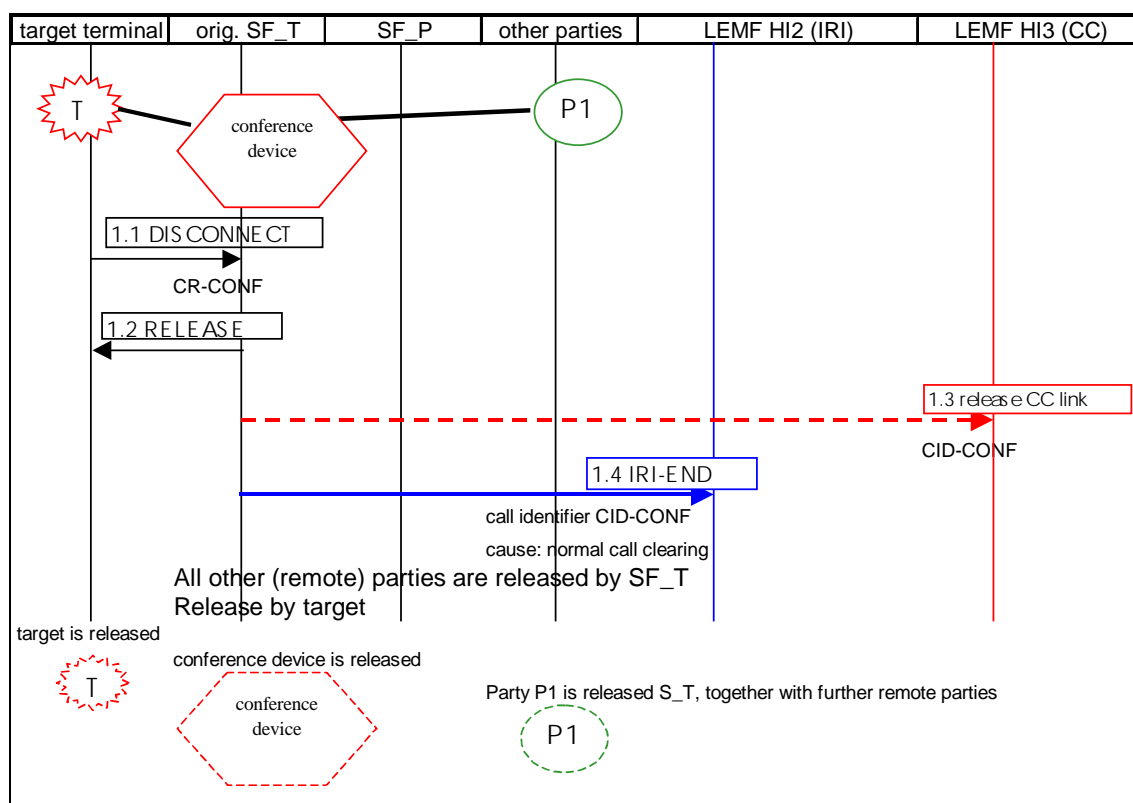

Figure E.20: Add-on Conference, target clears the conference

E.10.8 Option B (CC link only for active call)

The above sections assume option A. When using option B, only one CC link is needed. It is established during begin of the conference from idle, or reused from an existing active call (begin on from active). The CC links of calls, which are added to the conference, are released. In case of splitting a party, a new CC link needs to be set up.

In case of an ISDN BA, two CC links may exist, but the second set is only used, if two target calls are simultaneously in the Active Idle state (in the conversation phase); this is in general not the case within a conference configuration.

E.10.9 Add on conference using other protocols

The above sections assumed the use of the DSS1 functional protocol. For other protocols at the user network interface, which also support the Add on conference supplementary services, the possible actions are in principle the same, or a subset of the DSS1 functions. The resulting information shall be mapped to the Facility information elements of DSS1.

For the DSS1 keypad protocol, the same procedures are available as for the functional protocol.

In general, for analogue users, a conference may only begin from the idle state; the functions isolate, reattach and drop are not applicable.

E.11 Target exchange receives notification related to other party

In general applicable for IRI records are notifications on events related to other parties, which are specified within the service standards to be sent via the ISUP Generic Notification indicator, irrespective whether the ISUP is used or not, e.g. in purely local calls, within the SF_T.

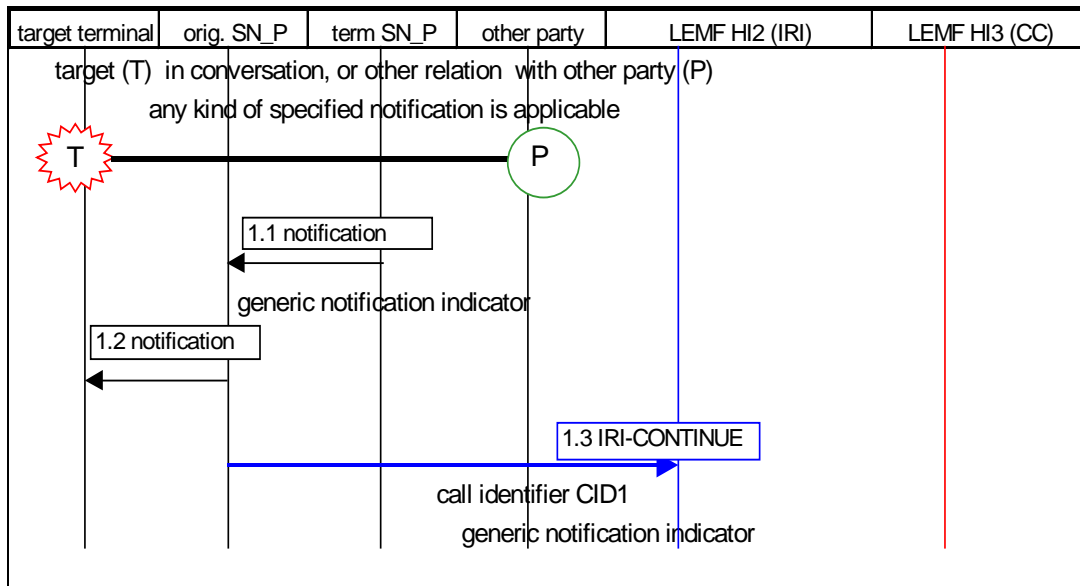

Figure E.21: Notification received, related to other party

E.12 Service Activation (not call related)

An IRI-REPORT record is sent after processing the subscriber request.

The IRI-REPORT record 2.2 contains the information, which has been received from the target during the activation procedure, see subclause 10.5.

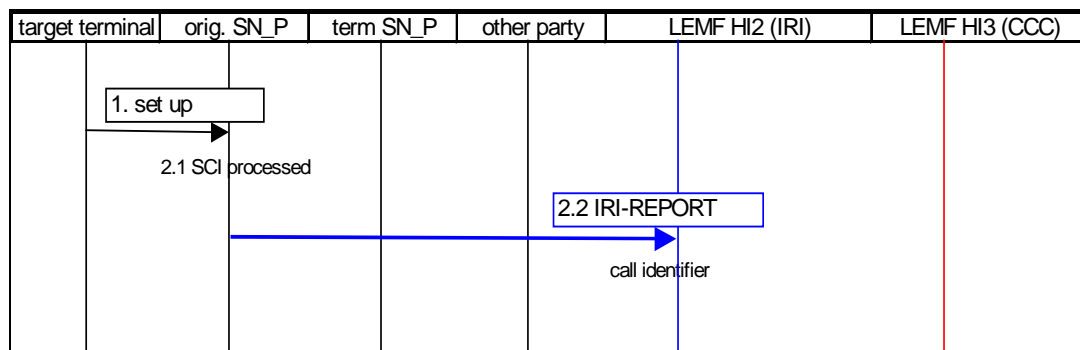

Figure E.22: Service activation, not related to a call

E.13 Service activation / invocation during a call

E.13.1 ISDN accesses

Service activation during an existing call constitutes a separate transaction, treated as specified in clause E.12 above.

Service invocations are actions related to a call, they are treated as parts of that call, i.e. reported via an IRI-CONTINUE record, if required.

E.13.2 Analogue accesses

A attempt to perform a service activation or invocation, while a call is active, starts in general by a flash signal, leading to putting the active call on hold, and setting up a new call leg. If the following action is not a new call set up, but an invocation of a service related to the existing active call (e.g. invocation of a 3PTY conference), the invocation may be reported, using a new call identifier value, within an IRI-REPORT record, or an IRI-BEGIN, (-CONTINUE), -END record transaction. In the latter case, a CC link has been set up. It may carry DTMF signals generated by the target for the service action; however, the resulting service action is reported in the specified way within an IRI record, which shall, in case of a service invocation; use the call identifier of the related call.

E.14 Unsuccessful calls from target (originating), IRI-BEGIN record sent

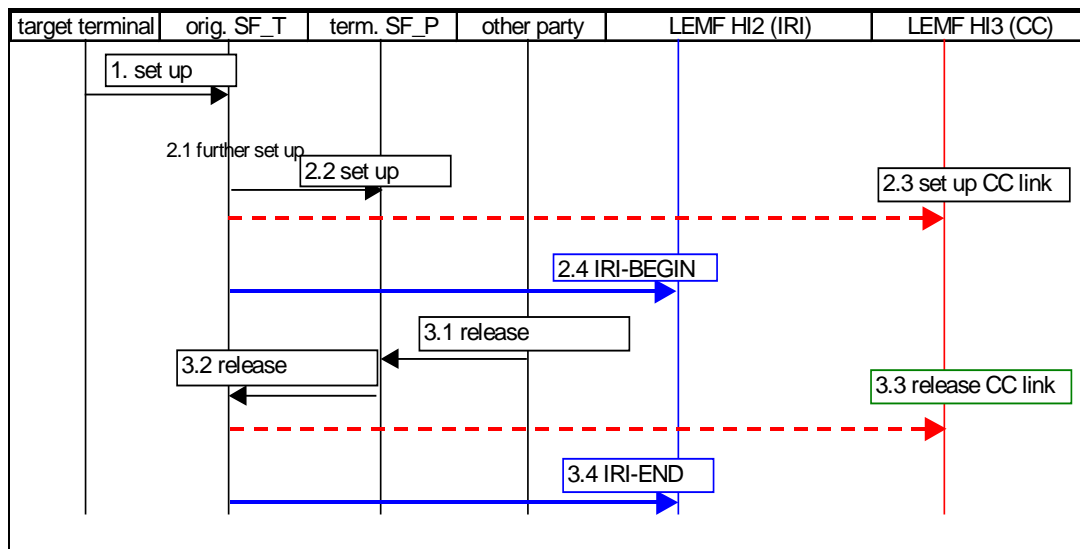

Figure E.23: Unsuccessful target call, reported by IRI-BEGIN, -END record

E.15 Unsuccessful calls from / to target, IRI-BEGIN record not sent

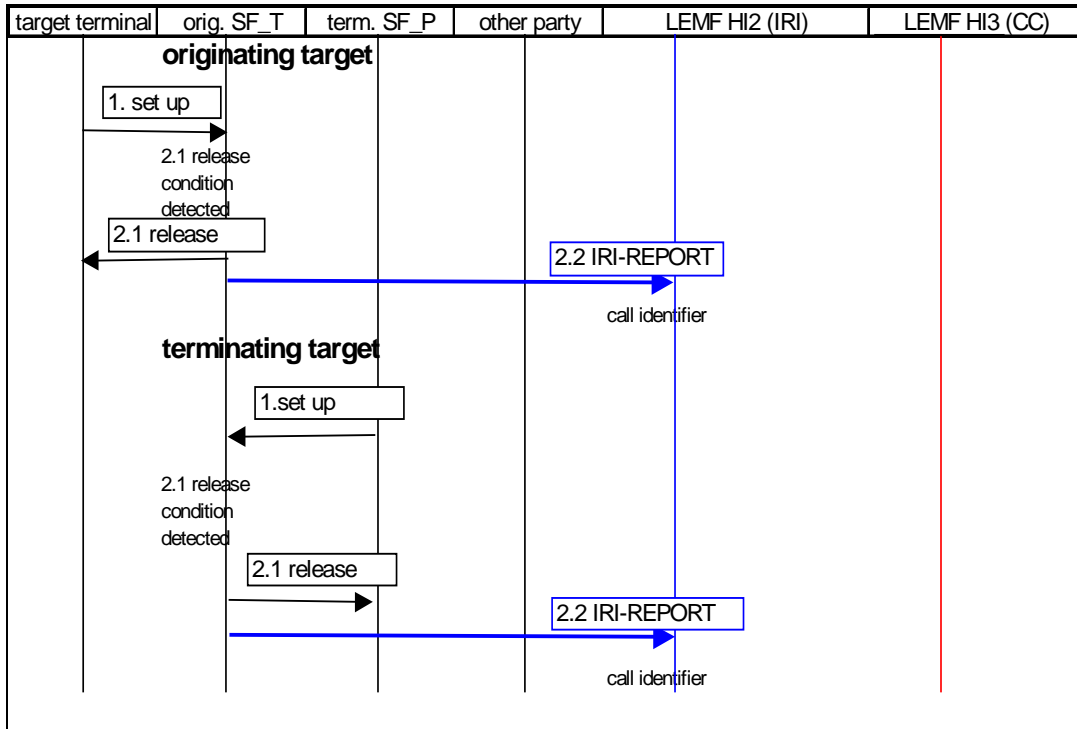

Figure E.24: Unsuccessful target call, reported by IRI-REPORT record

Annex F (informative): Use of subaddress to carry correlation information

F.1 Introduction

Not all ISDN networks fully support the use of the UUS1 service [23]. Some networks may be limited to the transfer of only 32 octets of UUS1 user information rather than the 128 required for full support of the UUS1 service. Some networks may not support UUS1 at all.

This informative annex describes a procedure to provide correlation information which is appropriate:

- a) if a network does not support the delivery of UUS1; or
- b) if a network does not support the delivery of 128 octets for UUS1.

If a network supports the delivery of 128 octets for UUS1 then this procedure is not appropriate, and the scheme of subclause 9.3.1 shall be used.

The called party subaddress is used to carry correlation information. The calling party sub-address is not used. The correlation information shall be coded as a maximum of 40 binary coded digits.

F.2 Subaddress options

The coding of a subaddress information element is given in [6]. The following options shall be chosen:

Table F.1

Option	Value
Type of subaddress	user specified
Odd/even indicator	(employed)

F.3 Subaddress coding

The coding of subaddress information shall be in accordance with [6].

F.3.1 BCD Values

The values 0-9 shall be BCD coded according to their natural binary values. The hexadecimal value F shall be used as a field separator. This coding is indicated in table F.2:

Table F.2

Item	BCD representation			
	Bit 4	Bit 3	Bit 2	Bit 1
0	0	0	0	0
1	0	0	0	1
2	0	0	1	0
3	0	0	1	1
4	0	1	0	0
5	0	1	0	1
6	0	1	1	0
7	0	1	1	1
8	1	0	0	0
9	1	0	0	1
Field separator	1	1	1	1

When items are packed two to an octet, the most significant item shall be coded by mapping bit 4 to bit 8, bit 3 to bit 7, etc.

F.3.2 Field order and layout

Fields shall be presented in to the subaddress in the following order:

Table F.3

Order	Field
1	LIID
2	NID
3	CIN
4	CCLID
5	Direction
6	Basic service

Each field noted above shall be included, whether empty or not, and a field separator shall separate each field. When a field is empty, that shall be indicated by two consecutive field separators. There shall be no field separator after the final field (Basic service).

BCD digits shall be mapped two to an octet, the most significant item shall be coded by shifting its 4 bit representation 4 bits to the left, such that bit 8 is filled from bit 4, bit 7 from bit 3, etc.

A typical example of the subaddress information element is given below:

Table F.4

Bits 5-8	Bits 1-4	Octet
Called party subaddress identifier		1
Length of called party subaddress contents		2
Type of subaddress = user specified, odd/even indicator = even		3
LIID	LIID	4
LIID	LIID	5
LIID	Field separator	6
NID	NID	7
NID	NID	8
NID	NID	9
Field separator	CIN	10
CIN	CIN	11
CIN	Field separator	12
Field separator	Direction	13
Field separator	Basic Service	14

NOTE: The CCLID field, in this example, is empty.

F.4 Field coding

Each field shall employ decimal coding. Other values are not permitted.

F.4.1 Direction

The direction field shall be coded as follows:

Table F.5

Indication	Value
Mono mode (combined signal)	0
CC from target	1
CC to target	2

F.4.2 Basic Service

The basic service may require up to 12 octets fully to indicate the basic service employed. The indication is abbreviated and taken from octet 3 of the bearer capability information element [6].

The basic service field shall be coded as follows:

Table F.6

Indication	Value
Speech	0
Unrestricted digital information	1
restricted digital information	2
Note: for ITU compatibility only	
3,1 kHz audio	3
unrestricted digital information with tones/announcements	4
video	5

F.5 Length of fields

The maximum length of each field shall be as given in the table below:

Table F.7

Field	Maximum length (decimal digits)
LIID	6
NID	10
CIN	6
CCLID	6
Direction	1
Basic service	1

Bibliography

The following material, though not specifically referenced in the body of the present document (or not publicly available), gives supporting information.

- ETS 300 121: "Integrated Services Digital Network (ISDN); Application of the ISDN User Part (ISUP) of CCITT Signalling System No. 7 for international ISDN interconnections (ISUP version 1)".
- EN 300 052-1: "Integrated Services Digital Network (ISDN); Multiple Subscriber Number (MSN) supplementary service; Digital Subscriber Signalling System No. one (DSS1) protocol; Part 1: Protocol specification".
- EN 300 055-1: "Integrated Services Digital Network (ISDN); Terminal Portability (TP) supplementary service; Digital Subscriber Signalling System No. one (DSS1) protocol; Part 1: Protocol specification".
- EN 300 058-1: "Integrated Services Digital Network (ISDN); Call Waiting (CW) supplementary service; Digital Subscriber Signalling System No. one (DSS1) protocol; Part 1: Protocol specification".
- EN 300 064-1: "Integrated Services Digital Network (ISDN); Direct Dialling In (DDI) supplementary service; Digital Subscriber Signalling System No. one (DSS1) protocol; Part 1: Protocol specification".
- EN 300 092-1 including Amendment 2: "Integrated Services Digital Network (ISDN); Calling Line Identification Presentation (CLIP) supplementary service; Digital Subscriber Signalling System No. one (DSS1) protocol; Part 1: Protocol specification".
- EN 300 093-1: "Integrated Services Digital Network (ISDN); Calling Line Identification Restriction (CLIR) supplementary service; Digital Subscriber Signalling System No. one (DSS1) protocol; Part 1: Protocol specification".
- EN 300 141-1: "Integrated Services Digital Network (ISDN); Call Hold (HOLD) supplementary service; Digital Subscriber Signalling System No. one (DSS1) protocol; Part 1: Protocol specification".
- EN 300 210-1: "Integrated Services Digital Network (ISDN); Freephone (FPH) supplementary service; Digital Subscriber Signalling System No. one (DSS1) protocol; Part 1: Protocol specification".
- EN 300 359-1: "Integrated Services Digital Network (ISDN); Completion of Calls to Busy Subscriber (CCBS) supplementary service; Digital Subscriber Signalling System No. one (DSS1) protocol; Part 1: Protocol specification".
- EN 300 745-1: "Integrated Services Digital Network (ISDN); Message Waiting Indication (MWI) supplementary service; Digital Subscriber Signalling System No. one (DSS1) protocol; Part 1: Protocol specification".
- EN 301 001-1 (V1.1): "Integrated Services Digital Network (ISDN); Outgoing Call Barring (OCB) supplementary services; Digital Subscriber Signalling System No. one (DSS1) protocol; Part 1: Protocol specification".
- EN 301 065-1 (V1.1): "Integrated Services Digital Network (ISDN); Completion of Calls on No Reply (CCNR) supplementary service; Digital Subscriber Signalling System No. one (DSS1) protocol; Part 1: Protocol specification".
- ITU-T Recommendation Q.699: "Interworking between ISDN access and non-ISDN access over ISDN User Part of Signalling System No. 7".
- ITU-T Recommendation I.210: "Principles of telecommunication services supported by an ISDN and the means to describe them".

History

Document history		
V1.1.1	May 1999	Membership Approval Procedure MV 9927: 1999-05-04 to 1999-07-02
V1.1.1	July 1999	Publication